

SSERIES

INSTALLATION, OPERATION, PARTS LIST, AND MAINTENANCE MANUAL

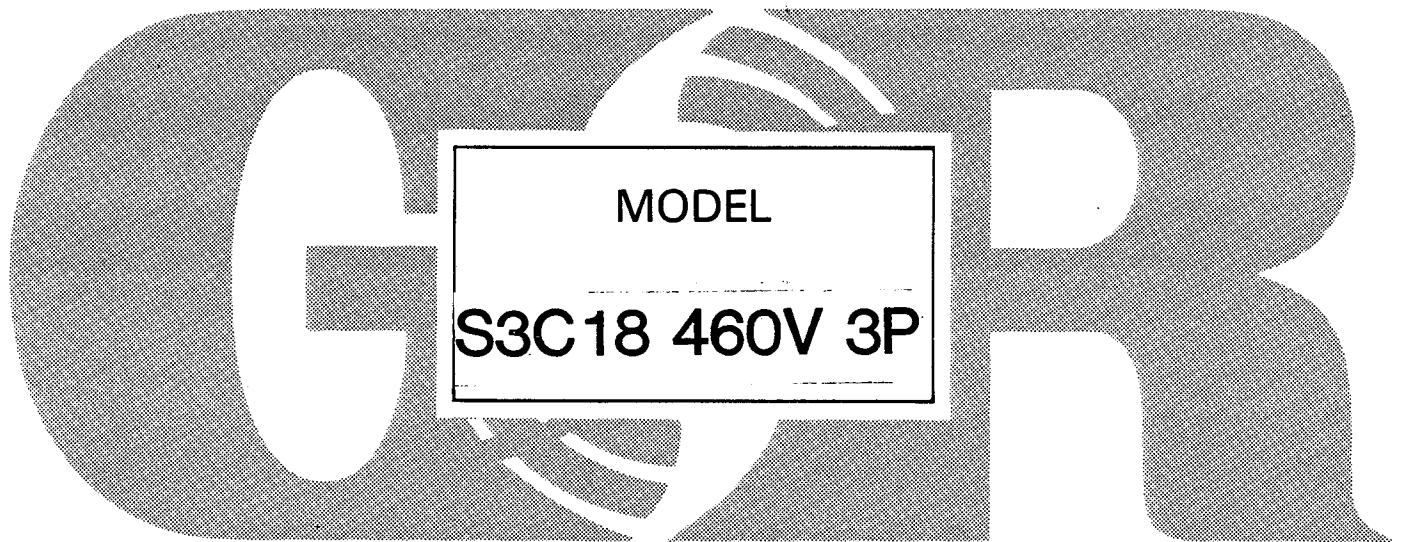

THE GORMAN-RUPP COMPANY • MANSFIELD, OHIO

GORMAN-RUPP OF CANADA LIMITED • ST. THOMAS, ONTARIO, CANADA

Printed in U.S.A.

TABLE OF CONTENTS

INTRODUCTION	I-1
WARNINGS - SECTION A	A-1
INSTALLATION - SECTION B	B-1
PREINSTALLATION INSPECTION	B-1
Lubrication	B-2
PUMP INSTALLATION	B-2
Pump Specifications	B-2
Pump Dimensions	B-2
Lifting	B-3
Positioning The Pump	B-4
Piping	B-5
CONTROL BOX INSTALLATION	B-6
Enclosure	B-6
Dual Voltage Motor Wiring Instructions	B-6
Grounding Methods	B-10
Field Wiring Connections (Incoming Power)	B-11
Pump Power Cable Connections	B-12
LIQUID LEVEL DEVICES	B-13
OPERATION - SECTION C	C-1
CONTROL BOX FUNCTION	C-1
Component Function	C-1
PUMP OPERATION	C-2
Liquid Temperature And Overheating	C-2
Checking Pump Rotation	C-3
STARTING	C-4
Standard Pump (No Liquid Level Devices)	C-5
With Automatic Liquid Level Devices	C-5
STOPPING	C-5
Operation Checks	C-5
Cold Weather Preservation	C-6
TROUBLESHOOTING - SECTION D	D-1
TROUBLESHOOTING CHART	D-1
ELECTRICAL TESTING	D-4
Test Equipment	D-4
Voltage Imbalance	D-4
Motor And Motor Power Cable Continuity	D-5
Insulation Resistance	D-6
MAINTENANCE AND REPAIR - SECTION E	E-1
PERFORMANCE CURVE	E-1
PUMP MODEL - PARTS LIST	E-3
PUMP AND MOTOR DISASSEMBLY AND REASSEMBLY	E-4
PUMP END DISASSEMBLY	E-5
Strainer Disassembly	E-5
Draining Oil From Seal And Motor	E-5
Positioning Pump For Disassembly	E-5
Impeller Disassembly	E-6
Lower Seal Disassembly	E-6
Upper Seal Disassembly	E-7
PUMP END REASSEMBLY	E-7
Cleaning Old Parts	E-7
Upper Seal Reassembly	E-9
Lower Seal Reassembly	E-10
Impeller Reassembly	E-11
Strainer Reassembly	E-11
MOTOR DISASSEMBLY	E-12
Terminal Housing And Power Cable Disassembly	E-12

Rotor Disassembly	E-13
Stator Disassembly	E-13
Relief Valve	E-14
Hoisting Bail	E-14
MOTOR REASSEMBLY	E-15
Stator Reassembly	E-15
Rotor Reassembly	E-16
Terminal Housing And Power Cable Reassembly	E-17
LUBRICATION	E-18
Seal Cavity	E-19
Motor Housing Cavity	E-19
FINAL ASSEMBLY	E-19

INTRODUCTION

This Installation, Operation, and Maintenance Manual is designed to help you achieve the best performance and longest life from your Gorman-Rupp pump.

This pump is designed to operate fully or partially submerged. It is capable of handling most nonvolatile and nonflammable liquids which are mildly corrosive and abrasive. The basic material of construction is aluminum with bonded buna-n linings over the suction head and seal plate; the impeller, strainer, fastening hardware and pipe plugs are stainless steel. The integral dual voltage electric motor must be operated through the control box furnished with the pump. Neither the pump motor nor control box are explosion proof and should not be operated in a hazardous atmosphere.

If there are any questions regarding the pump or motor which are not covered in this manual or in other literature accompanying this unit, please contact your Gorman-Rupp distributor or the Gorman-Rupp Company:

The Gorman-Rupp Company	or	Gorman-Rupp of Canada Limited
P.O. Box 1217		70 Burwell Road
Mansfield, Ohio 44901-1217		St. Thomas, Ontario N5P 3R7

The following are used to alert maintenance personnel to procedures which require special attention, to those which could damage equipment, and to those which could be dangerous to personnel:

NOTE

Instructions to aid in installation, operation, and maintenance or which clarify a procedure.

CAUTION

Instructions which must be followed to avoid causing damage to the product or other equipment incidental to the installation. These instructions describe the requirements and the possible damage which could result from failure to follow the procedures.

WARNING

```

////////////////////////////////////
//
// These instructions must be followed to avoid causing in- //
// jury or death to personnel, and describe the procedure //
// required and the injury which could result from failure //
// to follow the procedure. //
// //
////////////////////////////////////

```

WARNINGS

WARNINGS - SECTION A

THESE WARNINGS APPLY TO THE "S-SERIES" SUBMERSIBLE MOTOR OPERATED PUMPS.

WARNING

```

////////////////////////////////////
//
// Before attempting to open or service the pump:
//
// 1. Familiarize yourself with this manual.
// 2. Lock out the power supply to the control panel to
// ensure that the pump will remain inoperative.
// 3. Allow the pump to cool if overheated.
// 4. Close the discharge valve (if used).
//
////////////////////////////////////

```

WARNING

```

////////////////////////////////////
//
// Do not attempt to pump volatile or flammable liquids for
// which this pump has not been designed.
//
////////////////////////////////////

```

WARNING

```

////////////////////////////////////
//
// Before connecting any cable to the control box, be sure
// to ground the control box. See Figure 5 on page B-10
// for suggested grounds.
//
////////////////////////////////////

```

WARNING

```

////////////////////////////////////
//
// After the pump has been installed, make certain that the
// pump and all piping or hose connections are secure be-
// fore operation.
//
////////////////////////////////////

```

WARNING

```

////////////////////////////////////
//
// The pump motor is designed to be operated through the
// control box furnished with the pump. The control box
// provides overload protection and power control. Do not
// connect the pump motor directly to the incoming power
// lines.
//
////////////////////////////////////

```

WARNINGS

WARNING

```

////////////////////////////////////
//
// All electrical connections must be in accordance with //
// the National Electric Code and all local codes. If //
// there is a conflict between the instructions provided //
// and N.E.C. specifications, N.E.C. specifications shall //
// take precedence. All electrical equipment supplied with //
// this pump was in conformance with N.E.C. requirements in //
// effect on the date of manufacture. Failure to follow //
// applicable specifications, or substitution of electrical //
// parts not supplied or approved by the manufacturer, can //
// result in severe injury or death. //
//
////////////////////////////////////

```

WARNING

```

////////////////////////////////////
//
// The electrical power used to operate this pump is high //
// enough to cause injury or death. Make certain that the //
// control box is grounded, and that the power supply is //
// compatible with the motor phase and voltage, before con- //
// necting the power source. If the overload unit is //
// tripped during pump operation, correct the problem be- //
// fore restarting the pump. //
//
////////////////////////////////////

```

WARNING

```

////////////////////////////////////
//
// Obtain the services of a qualified electrician to con- //
// nect the electrical circuits, and to service the control //
// box. //
//
////////////////////////////////////

```

WARNING

```

////////////////////////////////////
//
// Do not attempt to lift the pump by the motor power cable //
// or the piping. Attach proper lifting equipment to the //
// hoisting bail fitted to the pump. //
//
////////////////////////////////////

```

INSTALLATION - SECTION B

This section is intended only to summarize recommended installation practices for the pump and control box. If there are any questions concerning your specific installation, contact your Gorman-Rupp distributor or the Gorman-Rupp Company.

Automatic liquid level devices are not furnished with the standard pump, but are available from Gorman-Rupp as options (see **Liquid Level Devices**, Section B); for information on installing and operating these devices, see the technical data accompanying that option.

PREINSTALLATION INSPECTION

The pump assembly and control box were inspected and tested before shipment from the factory. Before installation, check for damage which may have occurred during shipment. Check as follows:

- a. Check the pump assembly for cracks, dents, damaged threads, and other obvious damage.
- b. Check for and tighten loose bolts, nuts, capscrews, and other attaching hardware. Since gaskets tend to shrink after drying, check for and tighten loose hardware securing all mating surfaces.
- c. The standard pump is connected to the control box with 50 ft. of power cable. Inspect the cable for cuts or damage.
- d. Check the control box for cracks, dents, and other obvious damage.
- e. Check that all control box components are securely attached to their mounting surfaces, and that the electrical connections are tight and free of corrosion.
- f. Compare the amperes, phase, voltage, and hertz indicated on the motor name plate to the ratings indicated for the control box.
- g. Carefully read all tags, decals, and markings on the pump assembly and the control box, and perform all duties indicated.
- h. Check the pump and motor for any oil leaks. An oil leak may indicate a cut O-ring or other damage.
- i. If the pump and control box have been stored for more than 12 months, some of the components or lubricants may have exceeded their maximum shelf life. These **must be inspected or replaced** to insure maximum pump service.

If the maximum shelf life has been exceeded, or if anything appears to be abnormal, contact your Gorman-Rupp distributor or the factory to determine the repair or updating policy. **Do not** put the pump into service until appropriate action has been taken.

Lubrication

There are two lubrication cavities in this pump, both contain a premium quality hydraulic oil. The motor housing cavity provides lubrication to the motor assembly and rotor shaft bearings. The intermediate cavity provides lubrication to the seal assembly.

There are two shaft seals in this pump. The lower seal prevents liquid from entering the intermediate cavity at the impeller end. The upper seal prevents oil leakage from the motor housing cavity and acts as back-up protection in the event of lower seal failure.

Both lubrication cavities are fully lubricated when the pump is shipped from the factory. Check lubrication levels before installing the pump (see **LUBRICATION** in **MAINTENANCE AND REPAIR**). An additional quart of hydraulic oil has been provided with the pump to "top off" the oil cavities. If either oil level is abnormally low, determine the cause before putting the pump into service.

PUMP INSTALLATION

Pump Specifications

See Table 1 for the typical pump specifications and motor data.

Table 1. Pump Specifications

Model Number	Voltage/Phase	Pump Horse-power	Motor Speed (RPM)	Full Load Amperes	No Load Amperes	Locked Rotor Amperes	Discharge Size (NPT)
S3C18	230/3	6	3450	23	12	100	3
S3C18	460/3	6	3450	11.5	6	50	3

Pump Dimensions

The standard pump is provided with a suction strainer to prevent large solids from clogging the impeller. On high discharge head applications, the strainer can be replaced with an optional staging adaptor to allow one pump to feed another.

See Figure 1 on page B-3 for the approximate physical dimensions of the pump.

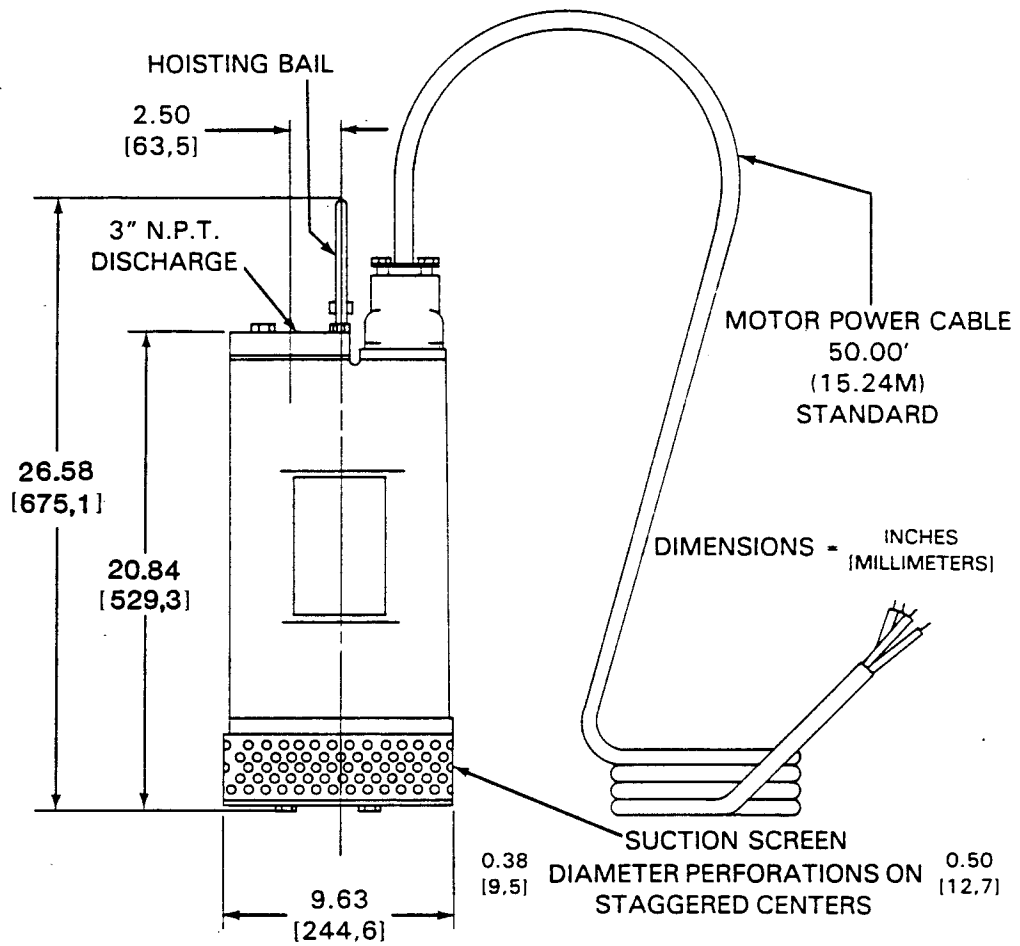

Figure 1. Pump Model S3C18-460V 3P

Lifting

Use lifting equipment with a capacity of a least **600 pounds**. This pump weighs approximately **120 pounds**, not including the weight of accessories and control box. Customer installed equipment such as rigid piping **must** be removed before attempting to lift.

• INSTALLATION

WARNING

```

////////////////////////////////////
//
// Do not attempt to lift the pump by the motor power cable //
// or the piping. Attach proper lifting equipment to the //
// hoisting bail fitted to the pump. If chains or cable //
// are wrapped around the pump to lift it, make certain //
// that they are positioned so as not to damage pump, and //
// so that the load will be balanced. //
// //
////////////////////////////////////

```

Positioning The Pump

This pump is designed to operate fully or partially submerged. It may also be operated in air for extended periods. The rotating parts are oil lubricated, and the motor is cooled by a constant flow of liquid or air discharged through internal passage(s).

As a safe guard against rupture or explosion due to heat, the pump is fitted with a pressure relief valve which will open if vapor pressure within the pump motor reaches a critical point.

The pump will operate if positioned on its side, but this is not recommended because the motor torque could cause the pump to roll during operation.

The pump should be independently secured and supported by the hoisting bail. If the application involves a lot of debris, protect the pump from excessive wear and clogging by suspending it in a perforated barrel or culvert pipe. If the bottom is heavily sludge-covered, rest the pump on support blocks or suspend it from a raft or similar device near the surface of the liquid. See Figure 2 on page B-5 for typical pump installations.

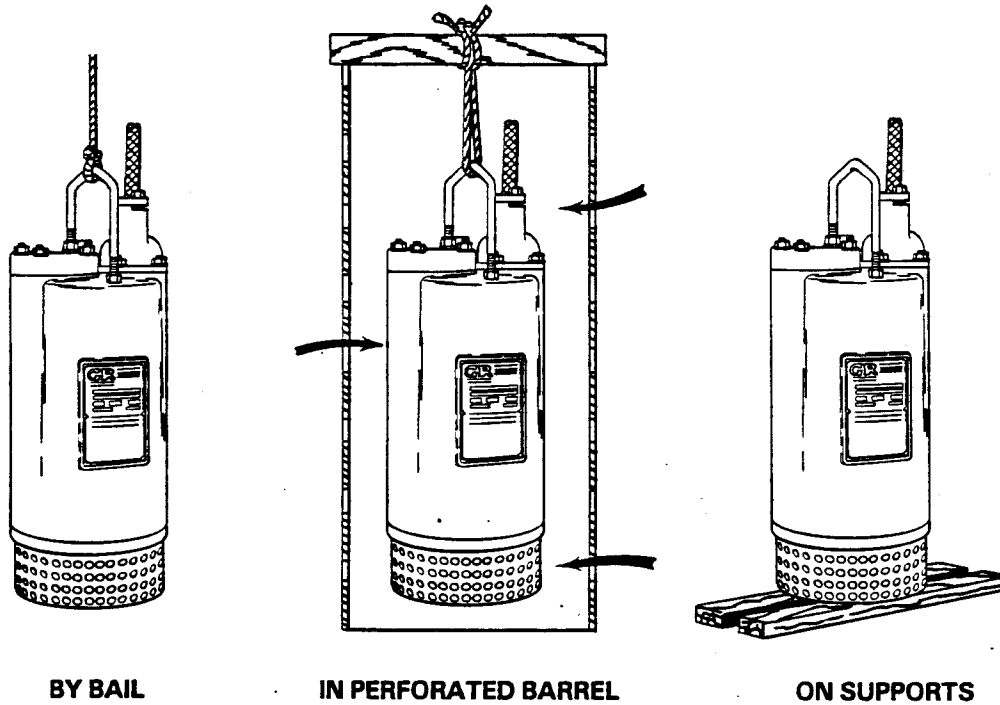

Figure 2. Typical Pump Installations.

All liquid entering the pump must pass through a strainer screen. Any spherical solids which pass through the screen will pass through the pump.

NOTE

Before actual operation, check the direction of impeller rotation to ensure that the pump is properly wired to the control box. See **Checking Pump Rotation** in **OPERATION** section.

Piping

No suction piping is required in a standard submerged application.

If an optional suction staging adaptor is installed, the discharge from one pump may be piped to the suction of another. To determine the size of the discharge connection, see Table 1, **PUMP SPECIFICATIONS**. Either hose or rigid pipe may be used. To facilitate mobility and maintenance, it is recommended that the discharge line be fitted with a quick disconnect fitting near the pump. The discharge line must be independently supported to avoid strain and vibration on the pump.

INSTALLATION

For maximum pumping capacity, keep the discharge as short and straight as possible. Minimize the use of elbows and fittings which increase friction losses through the discharge piping system.

It is recommended that a check valve or throttling valve be installed in the discharge line to control siphoning or back flow when the pump is shut off.

CONTROL BOX INSTALLATION

This pump is driven by an integral 460 VAC, 60 hertz, 3 phase, 6 HP motor. It is designed to operate through the control box furnished with the pump.

WARNING

Warning text enclosed in a double slash format with a border of slashes.

Enclosure

The control box is a rainproof enclosure with a padlockable front cover. The enclosure is not designed to be watertight, and should not be submerged. See Figure 4 on page B-8 for enclosure dimensions and callouts.

Secure the control box vertically on a level surface, which is above flood level. It should be easily accessible to the operator, and located close enough to the pump to avoid excessive voltage drop due to cable length. (See Pump Power Cable Connections). After the box is installed, make certain the front cover latches properly.

CAUTION

Failure to mount the control box vertically on a level surface may affect operation of the pump controls.

Dual Voltage Motor Wiring Instructions

This pump is powered by a dual voltage motor which permits utilization of high or low voltage. The motor was originally wired and shipped for the voltage indicated as "Factory Wired" on the pump's name plate. The name plate also indicates the dual voltages pertaining to this motor. If the alternate voltage must be utilized, certain wiring and control box modifications are required.

The control box assembly provided with this pump has been designed to accommodate **only** the voltage indicated on the front of the box. This voltage coincides with the "Factory Wired" voltage of the motor. If the alternate voltage is utilized, the control box must be replaced with another box designed for the appropriate voltage. Consult the Parts List under Options (Section E, Page 3) to determine the part number of the alternate voltage control box.

The motor wiring **must** also be changed. For detailed instructions on disassembly and reassembly of the terminal housing, see **Terminal Housing and Power Cable Disassembly** and **Terminal Housing and Power Cable Reassembly** in this manual (Section E). Change the motor leads as indicated on the wiring diagram plate affixed to the side of the terminal housing, see Figure 3. Be sure to tag the revised voltage on the pump.

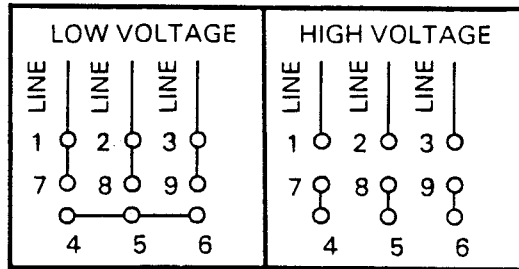

Figure 3. Motor Wiring Diagram

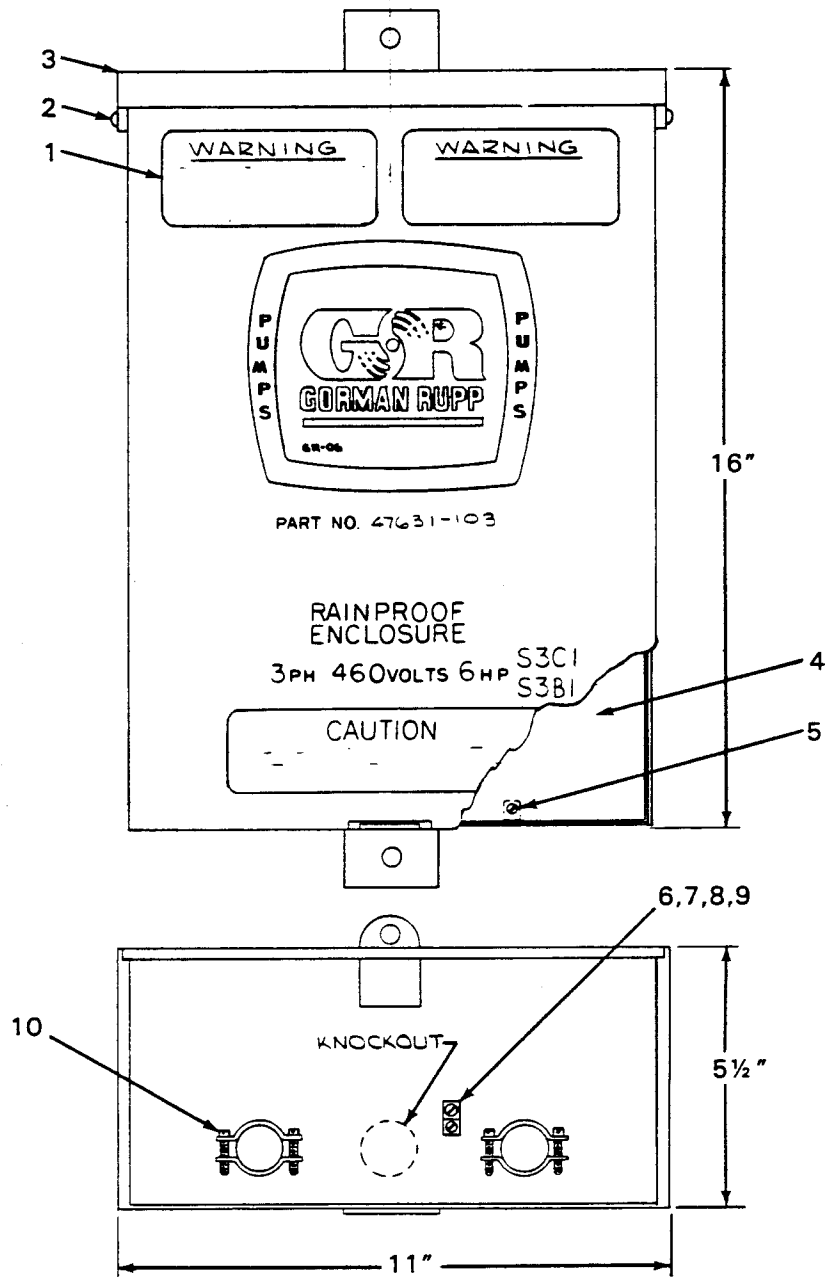

Figure 4. 47631-103 Control Box Assembly

PARTS LIST, EXTERNAL PARTS
47631-103 CONTROL BOX ASSEMBLY
 See Figure 9 on page B-16 for internal parts.

ITEM NO.	PART NAME	PART NUMBER	MATL CODE	QTY
1	FRONT COVER	42821-075	-----	1
2	TUBULAR RIVET	21118-008	-----	2
3	ENCLOSURE	42821-063	-----	1
4	INNER PANEL	42821-070	-----	1
5	PHILLIP HD MACHINE SCREW	CF#802	15991	2
6	PHILLIP HD MACHINE SCREW	CF#802	15991	2
7	GROUND LUG	27222-002	-----	2
8	LOCKWASHER	AK#8	15991	2
9	HEX NUT	D#8	15991	1
10	CABLE CLAMP	27184-164	-----	2

Grounding Methods

Electrically ground the installation before connecting the field wiring to the control box. Install a grounding terminal to the enclosure and connect it to a properly imbedded electrode.

The material used for the electrode **must** be an excellent conductor of electricity, such as copper. If iron or steel is used, it must be galvanized or otherwise metal plated to resist corrosion. **Do not** coat the electrode with any material of poor conductivity such as paint or plastic.

The electrode must conform to the recommendations of N. E. C. Article 250. Follow all installation requirements of the N.E.C., and all applicable local codes. See Figure 5 for some suggested grounding methods.

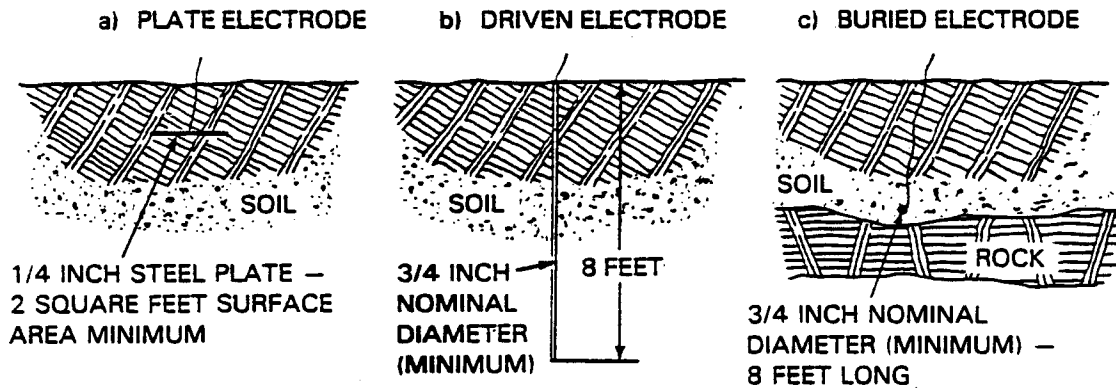

Figure 5. Suggested Grounding Methods

- a. **Plate Electrode:** An iron or steel plate, 1/4 inch thick, completely imbedded in the ground. The plate must present a surface of a least 2 square feet.
- b. **Driven Electrode:** A rod or pipe, 3/4 inch diameter minimum, 8 feet long, completely driven into the ground.
- c. **Buried Electrode:** If rock or stone prevents imbedding the full 8-foot length of the ground rod, bury it in a horizontal trench.

Space the ground rod or plates at least 6-feet from any other electrode or ground rod, such as those used for signal circuits, radio grounds, lightning rods, etc.

The earth surrounding the ground rod or plate **must** contain enough moisture to make a good electrical connection. In dry or sandy areas, pour water around the rod or consult qualified personnel to devise a method of improving the connection.

WARNING

```

////////////////////////////////////
//
// The electrical power used to operate this pump is high //
// enough to cause injury or death. Make certain that the //
// control box is properly grounded after installation. //
//
////////////////////////////////////
    
```

Field Wiring Connections (Incoming Power)

WARNING

```

////////////////////////////////////
//
// The electrical power used to operate this pump is high //
// enough to cause injury or death. Obtain the services of //
// a qualified electrician to make all electrical con- //
// nections. Make certain that the pump and enclosure are //
// properly grounded, and that the incoming power matches //
// the requirements of the pump and control. //
//
////////////////////////////////////
    
```

The pump control is designed to regulate a 460 volt, 3 phase, 60 hertz power supply. The field wiring must be properly sized to insure an adequate voltage supply. The voltage available **at the motor** must be within the range indicated in Table 2.

To calculate the voltage available at the motor proceed as follows:

- a. Measure the incoming voltage across lines (1 & 2, 2 & 3, and 1 & 3.) while the pump is **operating at full capacity**. See Figure 7 on page B-15 or Figure 9 on page B-16.
- b. Next, subtract the motor cable voltage drop (see Table 3, Motor Cable Specifications).
- c. Do not continue to operate the pump if this voltage is not within the recommended limits. Obtain the services of a qualified electrician to determine the correct field wiring size and other details to insure an adequate voltage supply to the pump.

Table 2. Pump Motor Voltage Limits

Nominal Voltage	Phase	Minimum Voltage	Maximum Voltage
230	3	210	250
460	3	420	500

INSTALLATION

Use conduit or cable clamps to secure the incoming field wiring to the control box. Make certain all connections are tight and that cable entry points are rainproof. Support the cable weight, if required, to prevent excessive strain on cable clamps and cable.

Pump Power Cable Connections

WARNING

Warning text enclosed in slashes: The electrical power used to operate this pump is high enough to cause injury or death. Make certain that incoming power is OFF and LOCKED OUT before connecting power or accessory cables to the control box. Obtain the services of a qualified electrician to make all electrical connections.

The standard pump is provided with a 50-foot power cable factory wired into the terminal housing. (See Table 3 for cable specifications.) If a longer power cable is required, an optional cable assembly must be ordered from the factory. Splicing of the power cable is not recommended by the Gorman-Rupp Company due to safety and warranty considerations.

WARNING

Warning text enclosed in slashes: Never attempt to alter the length or repair any power cable with a splice. The pump motor and cable must be completely waterproof. Injury or death may result from alterations.

Table 3. Cable Requirements for Pump Electrical Connections, Model S3C18

Table with 7 columns: Voltage/Phase, A.W.G. Cable Size, Cable OD (inches), Conductor Dia. (inches), Amp Rating* at 30°C (amperes), DC Resistance at 25°C (ohms/1000 ft), Voltage Drop at Max. Load per 100 ft. Rows include 230/3 and 460/3 configurations.

*Applies only to S0 type cable. Refer to manufacturer's specifications for other cable.

Before connecting the pump power cable to the control box, make certain the incoming power is OFF and LOCKED OUT. Make certain the control box is PROPERLY GROUNDED and that the electrical data on the control matches the motor name plate data.

Connect the pump power cable to the control box as shown in Figure 7 on page B-15 or Figure 9 on page B-16. Use conduit or cable clamps to secure the power and accessory cables to the control box. Make certain that all connections are tight and that cable entry points are rainproof.

LIQUID LEVEL DEVICES

The standard pump is **not** furnished with a means to automatically regulate liquid level. However, the pump may be controlled to perform filling, or dewatering functions by using **either** of the following optional sensing devices: (see Figure 6 on page B-14).

- **Diaphragm Type:** two fixed position sensors (upper and lower) each contain a diaphragm which flexes with changes in liquid level, thus activating an enclosed miniature switch.
- **Bulb (Float) Type:** a bulb raises or lowers (floats) with the liquid level, thus activating an enclosed miniature switch.

For added safety, the sensing devices operate through low voltage (24 volt) circuitry which is specially designed to fit into the main pump control box.

The circuitry may be prewired as a factory option, or easily added in the field by qualified personnel. For installation and operation, see the detailed instructions included with the optional package.

TYPICAL INSTALLATION

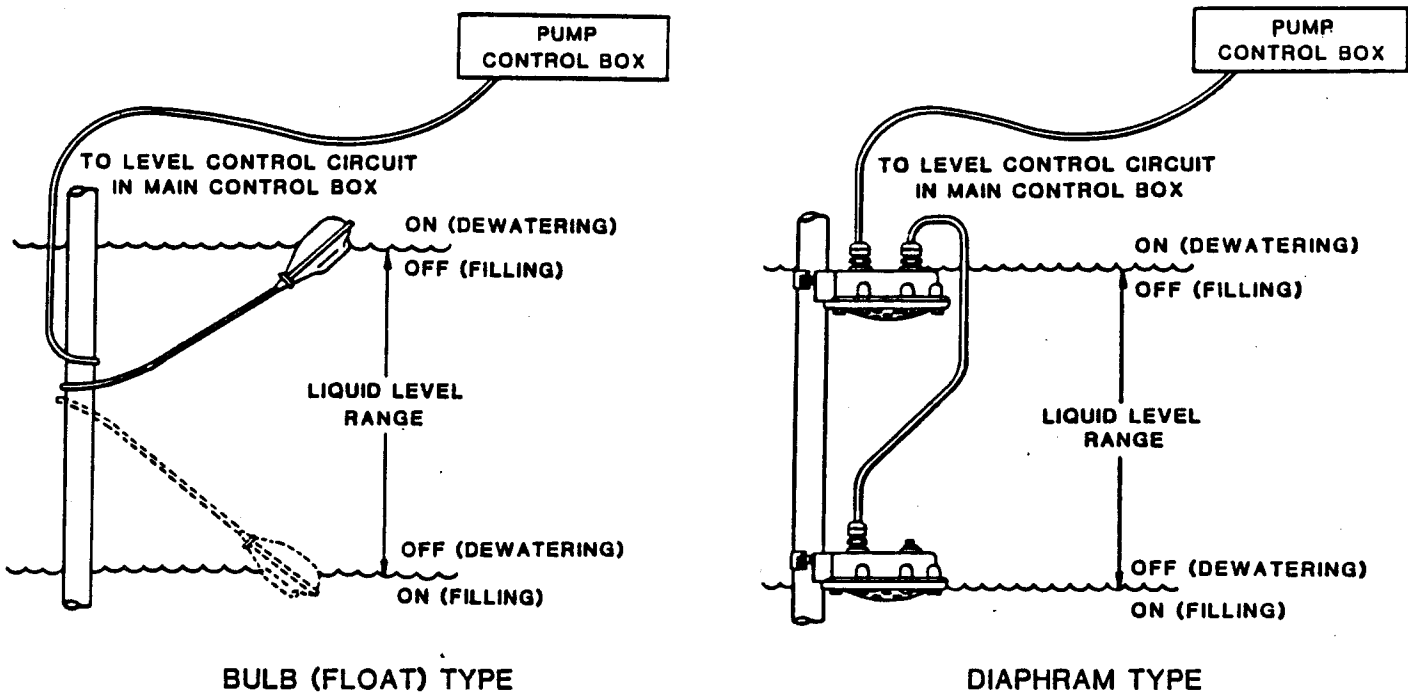

Figure 6. Liquid Level Devices

CAUTION

The internal wiring of the sensing devices are different for filling and dewatering functions. Be sure to follow the instructions included with the option before making wiring connections.

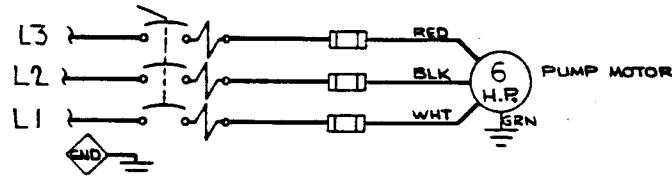

Figure 7. Elementary Wiring Diagram (Without Liquid Level Controls)

If liquid level controls are to be installed, connect the motor power cables and level control power cables as shown in Figure 8 and Figure 9 on page B-16.

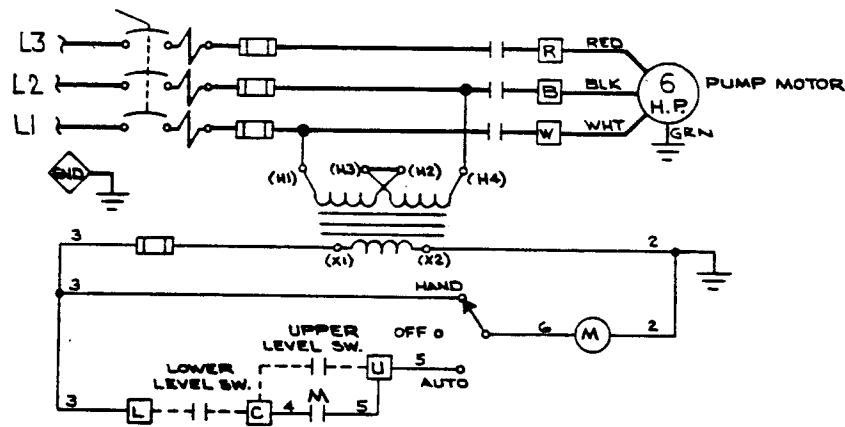

Figure 8. Elementary Wiring Diagram (With Liquid Level Controls)

See Figure 9 on page B-16 for a pictorial wiring diagram and callouts of the control box assembly internal parts.

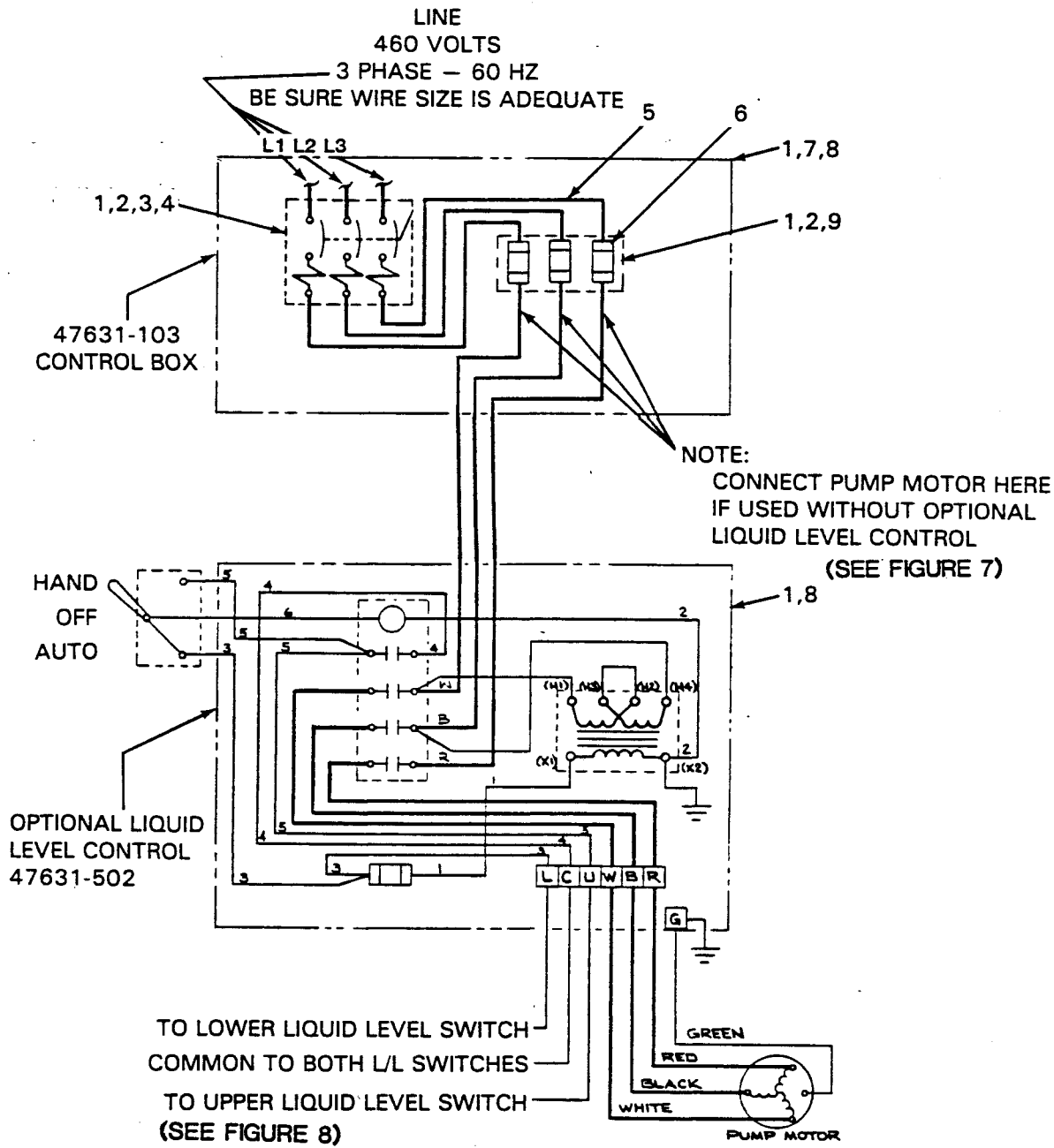

Figure 9. 47631-103 Control Box Assembly - Pictorial Wiring Diagram

PARTS LIST INTERNAL PARTS
47631-103 CONTROL BOX ASSEMBLY
See Figure 4 on page B-8 for external parts

ITEM NO.	PART NAME	PART NUMBER	MATL CODE	QTY
1	FLAT WASHER	K#8	15991	6
2	LOCKWASHER	AK#8	15991	15
3	PHILLIP HD MACHINE SCREW	CF#802	15991	9
4	OVERLOAD UNIT	9485-M	-----	1
5	WIRE ASSEMBLY	18142-133	-----	2
6	FUSE, 30 AMP	27311-120	-----	3
7	BACK PANEL	34621-062	-----	1
8	PHILLIP HD MACHINE SCREW	CF#801	15991	8
9	FUSE BLOCK	27314-306	-----	1

OPERATION

OPERATION - SECTION C

CONTROL BOX FUNCTION

WARNING

```

////////////////////////////////////
//
// This pump motor and control box are not designed to be //
// explosion proof. Do not operate in an explosive atmos- //
// phere. //
// //
////////////////////////////////////

```

A control box is provided to facilitate operation of the pump. It contains controls for starting and stopping the pump, and provides overload protection for the pump motor. The pump control may be equipped with an optional automatic liquid level sensing device, in which case the low voltage circuits are also contained within the control box.

WARNING

```

////////////////////////////////////
//
// The pump motor is designed to be operated through the //
// control box furnished with the pump. The control box //
// provides overload protection and power control. Do not //
// connect the pump motor directly to the incoming power //
// lines. //
// //
////////////////////////////////////

```

CAUTION

Since operation of the pump motor is dependent upon the quality and performance of the electrical controls, the pump warranty is valid only when controls have been specified or provided by the Gorman-Rupp Company.

Component Function

The control box contains the following hand operated switches and controls:

- The **tie handle** operates the control box overload unit. In the OFF position, the tie handle opens the overload unit to interrupt incoming power through the control box and prevent pump operation. In the ON position, it closes the overload unit to permit pump operation. The overload unit will open or "TRIP" automatically in the event of a short circuit overload current, or thermal excess within the pump motor or electrical system. When tripped, move the tie handle to OFF and back to ON to reset the overload unit.

OPERATION

- The **selector switch** (optional on some boxes) controls the mode of operation. In the OFF position, it prevents all operation of the pump. In the HAND position, it allows the pump to run continuously. In the AUTO position, it allows the pump to be controlled automatically by the optional liquid level control system, if used.

NOTE

If the overload unit trips, do not reset it immediately. Wait at least ten minutes before resetting the tie handle back to the ON position. If the overload unit continues to trip, operational problems exist. See TROUBLESHOOTING.

WARNING

```

////////////////////////////////////
//
// The motor will restart as soon as the tie handle is re- //
// set, unless the selector switch is in the OFF position. //
// Turn the selector switch to OFF and move the tie handle //
// to OFF before approaching the pump. //
// //
////////////////////////////////////

```

- The **liquid level devices** (optional equipment) operate in conjunction with the 3-position switch (HAND-OFF-AUTO) supplied as a part of that option. After the level sensors and circuitry have been installed, pump operation may be automatically controlled for filling or dewatering functions. (See LIQUID LEVEL DEVICES, Section B.)

PUMP OPERATION

WARNING

```

////////////////////////////////////
//
// This pump is designed to handle most nonvolatile and //
// nonflammable liquids which may be mildly corrosive or //
// abrasive. Do not attempt to pump liquids which may //
// damage the pump or endanger personnel as a result of //
// pump failure. //
// //
////////////////////////////////////

```

Liquid Temperature And Overheating

The **maximum** liquid temperature for this pump is 120° F.. Do not apply it at a higher operating temperature.

Overheating can occur if the pump is misapplied, or if the control box fails to provide adequate protection. Operating the pump against a closed discharge for extended period will also cause the pump to overheat.

OPERATION

As a safeguard against rupture or explosion due to heat, this pump is equipped with a pressure relief valve which will open if vapor pressure within the pump motor reaches a critical point. If overheating does occur, stop the pump immediately and allow it to cool before servicing it. **Approach any overheated pump cautiously.**

WARNING

```

////////////////////////////////////
//                               //
// Overheated pumps can cause severe burns and injury. If //
// overheating of the pump occurs:                               //
//                               //
//     1. Stop the pump immediately.                             //
//     2. Allow the pump to cool.                                 //
//     3. Refer to instructions in this manual before re- //
//         starting the pump.                                     //
//                               //
////////////////////////////////////

```

It is recommended that the pressure relief valve assembly be replaced at each overhaul, or any time the pump motor overheats and activates the valve. **Never** replace this valve with a substitute which has not been specified or provided by the Gorman-Rupp Company.

Checking Pump Rotation

Check the direction of pump rotation before operation to ensure that the impeller is rotating in the correct direction.

Suspend the pump from the hoisting bail. Turn it on momentarily and note the direction of twist. For correct rotation and operation, the twist must be in the **counterclockwise** direction when viewed from the **top**.

CAUTION

<p>Secure the pump during rotation check to prevent coiling of the power cable.</p>

OPERATION

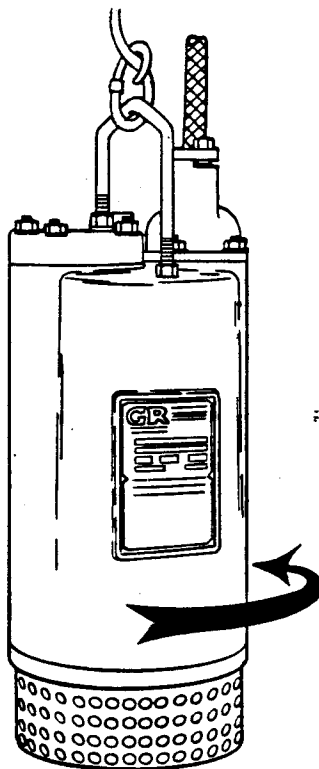

Figure 1. Checking Pump Rotation

If the pump twists clockwise on start, interchange any two motor leads at the control box.

WARNING

```

////////////////////////////////////
//                               //
// The electrical power used to operate this pump is high //
// enough to cause injury or death. Make certain that in- //
// coming power is OFF and LOCKED OUT before interchanging //
// motor leads.                                           //
//                                                       //
////////////////////////////////////

```

STARTING

After the pump and control box have been installed, start the pump as follows.

NOTE

Before actual operation, check the direction of impeller rotation to ensure that the pump is properly wired. See Checking Pump Rotation in OPERATION section.

Standard Pump (No Liquid Level Devices)

If no liquid level devices have been installed, move the tie handle to the ON position. The pump motor will start and pumping should begin. Since the pump is submerged, priming is not required.

The pump will continue to operate until it is stopped by turning the tie handle to OFF.

With Automatic Liquid Level Devices

If optional liquid level devices have been installed, move the 3-position selector switch to OFF and the tie handle to the ON position.

If desired to operate the pump in the manual mode, set the selector switch to HAND; the pump will continue to run until the switch is returned to OFF, or reset to AUTO.

If desired to operate the pump in the automatic mode, set the selector switch to AUTO; pump operation will be maintained by the optional liquid level control system. To terminate automatic mode, move the selector switch to OFF or HAND.

STOPPING

To stop pump operation, turn the tie handle OFF.

Power going to the pump from the control box is terminated by moving the tie handle to the OFF position, thereby opening the overload unit. This **does not** terminate incoming power through the field wiring connected to the control box.

After stopping the pump, be sure to perform all required maintenance and preservation procedures.

NOTE

It is recommended that a check valve or throttling valve be installed in the discharge line if there is any possibility of siphoning or back flow when the pump is shut off.

Operation Checks

Check the pump for proper operation when it is first started and periodically thereafter to identify minor problems.

Check the pump for unusual noises or excessive vibration while it is operating. If noise or vibration is excessive, stop the pump and refer to the troubleshooting chart for possible causes.

Check the pump strainer screen for clogging caused by stones, sticks, or other debris. Clean the strainer screen when required. In some cases, stopping the

pump momentarily may back flush the strainer screen, purging most of the debris from it. If this fails to clean the screen, remove the pump from the sump and remove the debris manually. See **PUMP DISASSEMBLY**.

Never introduce air or steam pressure into the pump casing or piping to remove a blockage. This could result in personal injury or damage to the equipment. If backflushing is absolutely necessary, **liquid pressure** must be limited to 50% of the maximum permissible operating pressure shown on the pump performance curve.

Check the pump for overheating. The pump could overheat if operated for an extended period with a closed valve in the discharge line.

Cold Weather Preservation

In freezing temperatures, the pump will not freeze as long as it is submerged in liquid. If the pump casing is not submerged, or if the liquid begins to freeze, remove the pump from the sump or wet well and allow it to dry thoroughly. Run the pump for two or three minutes to dry the inner walls.

If the pump freezes, move it into a warm area until completely thawed, or submerge it into the liquid. If the liquid is near freezing, the pump must be submerged for an extended period of time. Start the pump and check for shaft rotation. If still frozen, allow additional thawing time before attempting to restart.

WARNING

```

////////////////////////////////////
//                               //
// Do not attempt to thaw the pump by using a torch or oth- //
// er source of flame. This could damage gaskets or heat //
// the oil within the pump above the critical point and //
// cause the pump to rupture or explode. //
//                               //
////////////////////////////////////

```

TROUBLESHOOTING - SECTION D

WARNING

```

////////////////////////////////////
//
// The electrical power used to operate this pump is high //
// enough to cause injury or death. Obtain the services of //
// a qualified electrician to troubleshoot, test and/or //
// service the electrical components of this pump. //
//
////////////////////////////////////
    
```

Many of the probable remedies listed in the troubleshooting chart below require use of electrical test instruments; for specific procedures, see **Electrical Testing** at the end of the troubleshooting chart.

TROUBLESHOOTING CHART

TROUBLE	POSSIBLE CAUSE	PROBABLE REMEDY
PUMP FAILS TO START, OVERLOAD UNIT NOT TRIPPED (MANUAL MODE)	Power source incompatible with control box.	Correct power source.
	No voltage at line side of circuit breaker.	Check power source for blown fuse, open breaker, broken lead, or loose connection.
(AUTOMATIC MODE)	Open circuit in motor windings or power cable.	Check continuity.
	Defective motor power cable.	Replace cable.
	Motor defective.	Check for and replace defective unit.
	Liquid level device or control circuits improperly connected to main control box.	Check wiring diagrams; correct or tighten connections.
	Level sensing device(s) improperly positioned.	Position device(s) at proper level.
Level sensing device(s) fouled with mud or foreign material.	Clean sensing device(s).	

TROUBLE	POSSIBLE CAUSE	PROBABLE REMEDY
PUMP FAILS TO START, OVERLOAD UNIT NOT TRIPPED (AUTOMATIC MODE) (cont.)	<p>Float type sensing device(s) tangled or obstructed.</p> <p>Defective liquid level sensing device(s) or control panel.</p>	<p>Check installation for free movement of float.</p> <p>Repair or replace defective unit(s).</p>
OVERLOAD UNIT TRIPS	<p>Low or high voltage, or excessive voltage drop between pump and control box.</p> <p>Defective insulation in motor windings or power cable; defective windings.</p> <p>Impeller jammed due to debris or insufficient clearance.</p> <p>Bearing(s) frozen.</p> <p>Terminal housing incorrectly wired. (Dual voltage or single phase motors only).</p>	<p>Measure voltage at control box. Check that wiring is correct type, size, and length. (See Field Wiring Connection, Section B).</p> <p>Check insulation resistance; check continuity.</p> <p>Disassemble pump and check impeller.</p> <p>Disassemble pump and check bearing(s).</p> <p>Check terminal housing internal connections against motor wiring plate and schematic wiring diagram.</p>
MOTOR RUNS, BUT PUMP FAILS TO DELIVER RATED DISCHARGE	<p>Discharge head too high.</p> <p>Low or incorrect voltage.</p> <p>Discharge throttling valve partially closed; check valve installed improperly.</p> <p>Discharge line clogged or restricted; hose kinked.</p> <p>Liquid being pumped too thick.</p> <p>Strainer screen or impeller clogged.</p>	<p>Reduce discharge head, or install staging adaptor and additional pump.</p> <p>Measure control box voltage, both when pump is running and when shut off.</p> <p>Open discharge valve fully; check piping installation.</p> <p>Check discharge lines; straighten hose.</p> <p>Dilute liquid if possible.</p> <p>Clear clog(s). Stop pump; back flow may flush away debris.</p>

TROUBLE	POSSIBLE CAUSE	PROBABLE REMEDY
MOTOR RUNS, BUT PUMP FAILS TO DELIVER RATED DISCHARGE (cont.)	Insufficient liquid in sump or tank. Worn impeller vanes; excessive impeller clear- ance. Pump running backwards.	Stop pump until liquid level rises. Check impeller and clearance. See PUMP END REASSEMBLY. Check direction of rotation and correct by interchanging any two motor leads at control box. (See Pump Rotation, Section C).
PUMP RUNS WITH EXCES- SIVE NOISE OR VIBRATION	Pumping entrained air. Damaged or unbalanced impeller. Discharge piping not properly supported. Impeller jammed or loose. Motor shaft or bearings defective. Pump cavitation.	Check liquid level in sump; check position of pump and liquid level sensing device(s). Replace impeller. Check piping installation. Check impeller. Disassemble pump and check motor and bearings. Reduce discharge head, or restrict flow on low head appli- cations.

ELECTRICAL TESTING

If you suspect that pump malfunctions are caused by defects in the motor, power cable or control box, perform the following checks to help isolate the defective part.

WARNING

```

////////////////////////////////////
//                               //
// The electrical power used to operate this pump is high //
// enough to cause injury or death. Obtain the services of //
// a qualified electrician to troubleshoot, test and/or //
// service the electrical components of this pump. //
//                               //
////////////////////////////////////

```

CAUTION

<p>Be certain to refer to the wiring diagrams in the INSTALLATION section of this manual before reconnecting any electrical components which have been disconnected.</p>
--

Test Equipment

A volt/amp/ohmmeter and megohmmeter of adequate range and quality will be required to conduct the following electrical tests. The suggested equipment indicated below is commercially available, or an equivalent substitute may be used.

Equipment	Manufacturer	Use
Amprobe Model 300 or Amprobe, Jr.	Pyramid Instrument Corp. Lynbrook, NY	To check AC Voltage and current (amperage)
Megohmer	Herman H. Sticht Co. 25 Bark Place New York, N.Y.	To measure resistance (ohms) to ground

Voltage Imbalance

Each phase of the incoming three-phase power must be balanced with the other two as accurately as a commercial voltmeter will read. If the phases are balanced, check out the motor as described below. If the phases are out of balance, contact your power company and request that they correct the condition.

-
-
- a. Use a voltmeter, Amprobe, or equivalent meter to read the voltage across terminals 1 & 2, 2 & 3, and 1 & 3. in the control box. All three measured voltages must be the same, as accurately as the meter will read. If possible, measure the voltage with the pump off, with the pump running but out of the water, and with the pump running in the water at full load. All the measured voltages at each condition must be the same.
 - b. Use an Amprobe or equivalent meter to measure the current draw of each phase while the pump is running at full load and at no load. All three amperage readings must be the same at each condition, as accurately as the meter will read. Nominal amperage values are listed in Table 1, but these apply only when the actual voltage at the site is the nominal voltage listed.
 - c. If the voltages are balanced with the pump off, but are unbalanced when the pump is running, a thorough check of the power source, all interconnecting cables, and the pump motor is required to isolate the defect.

Motor And Motor Power Cable Continuity

To check continuity, zero-balance the ohmmeter set at the RX1 scale, and test as follows:

- a. Disconnect the motor power cable leads from the control box and connect the test leads to any two of the three power cable leads (not to the green ground lead). If there is a high resistance reading on the ohmmeter, there is an open or broken circuit caused by a break in the power cable or motor windings, or by a bad connection between the motor and the power cable. Switch one test lead to the third power lead, and test again.
- b. If an open or broken circuit is indicated, check the power cable for obvious damage, and replace as necessary (see **MAINTENANCE AND REPAIR**). If there is no apparent damage to the motor cable, remove the terminal housing (see **MAINTENANCE AND REPAIR**) and check the continuity of each power cable lead at the terminal posts.
- c. If an open circuit still exists after each lead (terminal) has been tested and tightened, then the **entire** motor power cable must be replaced. Splicing or other means of repair are not recommended.
- d. If no break is found in the power cable, check the motor leads for continuity. If the test reading indicates an open or broken circuit, there is an open circuit in the motor.

NOTE

It is recommended that a pump with a defective motor be returned to Gorman-Rupp, or to one of the Gorman-Rupp authorized Submersible Repair Centers.

Insulation Resistance

To check insulation, zero-balance the ohmmeter set at the RX100K scale, and test as follows:

- a. Disconnect the motor power cable leads from the control box. Connect one test lead to the power cable green ground lead, and touch the other test lead to each of the three power leads in turn.
- b. The reading obtained will indicate resistance values in both the power cable and the motor windings. If the resistance reading is infinity (∞), the insulation is in good condition. If the reading is between infinity (∞) and 1 megohm, the insulation is acceptable but should be rechecked periodically. If the reading is less than 1 megohm, the insulation should be checked more closely; a reading of zero indicates that the power cable or the motor is grounded.
- c. To determine whether the power cable or the motor is grounded, remove the terminal housing (see **MAINTENANCE AND REPAIR**), disconnect the motor leads from the motor terminals, and test the power cable leads and motor leads separately.

MAINTENANCE AND REPAIR

MAINTENANCE AND REPAIR - SECTION E

MAINTENANCE AND REPAIR OF THE WEARING PARTS OF THE PUMP WILL MAINTAIN PEAK OPERATING PERFORMANCE.

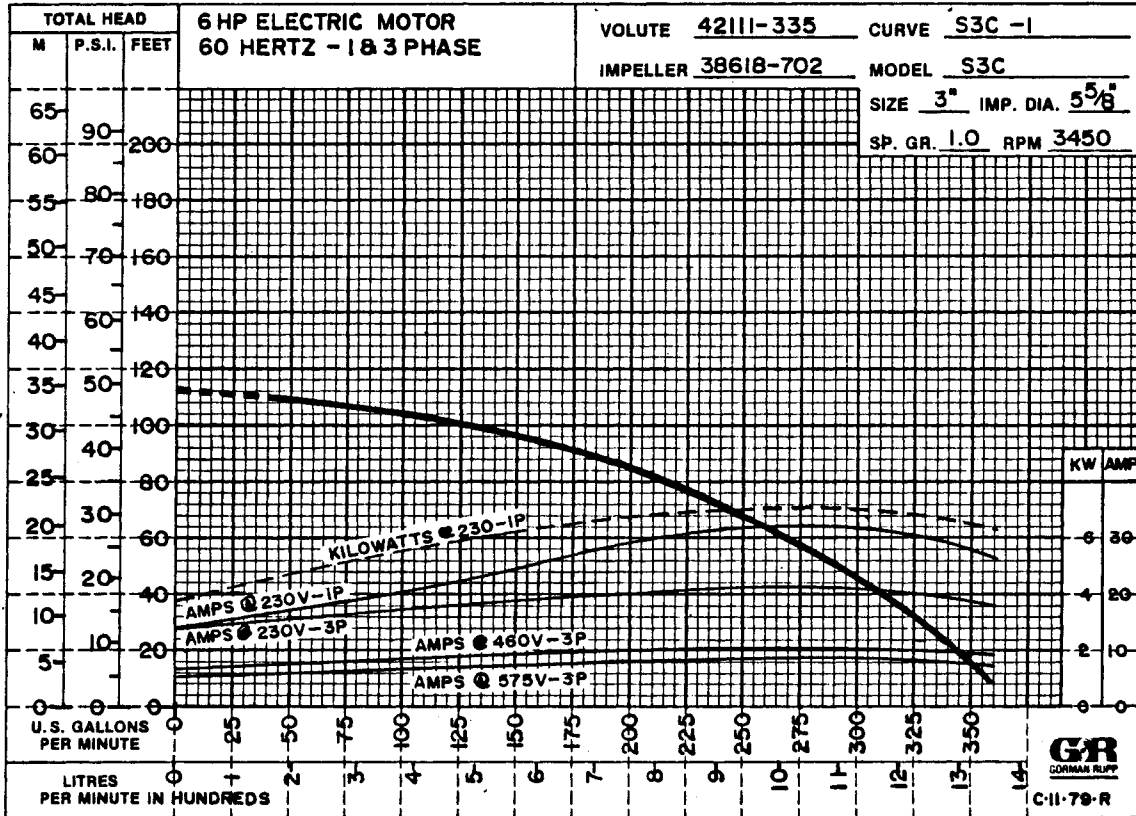

***STANDARD PERFORMANCE FOR PUMP MODEL S3C18-460V 3P**

*Based on 70°F clear water at sea level. Since pump installations are seldom identical, your performance may be different due to such factors as viscosity, specific gravity, elevation, temperature, and impeller trim.

If your pump serial number is followed by an "N", your pump is NOT a standard production model. Contact the Gorman-Rupp Company to verify performance or part numbers.

SECTIONAL DRAWING

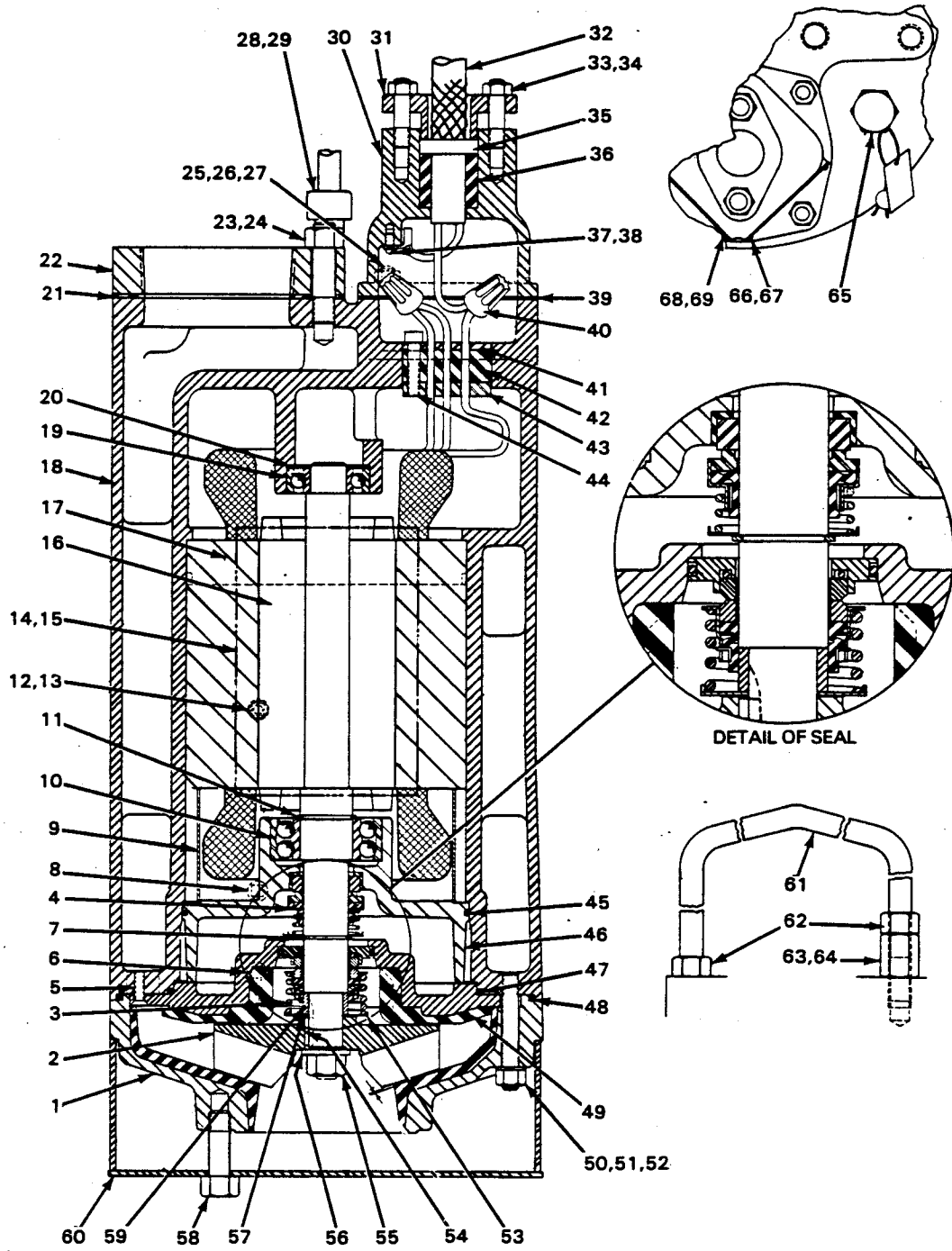

Figure 1. Pump Model S3C18-460V 3P

PARTS LIST
Pump Model S3C18-460V 3P
 (From S/N 806409 up)

If your pump serial number is followed by an "N", your pump is **NOT** a standard production model. Contact the Gorman-Rupp Company to verify part numbers.

ITEM NO.	PART NAME	PART NUMBER	MATL CODE	QTY	ITEM NO.	PART NAME	PART NUMBER	MATL CODE	QTY
1	BONDED SUCT HEAD	42111-335	24010	1	44	SKCT HD CAPSCREW	13879	15990	4
2	*IMPELLER	38618-702	1718H	1	45	*INTERM O-RING	25152-258	-----	1
3	*LOWER SEAL ASSY	25277-345	-----	1	46	INTERMEDIATE	38311-803	13040	1
4	*UPPER SEAL ASSY	S01832	-----	1	47	*SEAL PLT O-RING	S02194	-----	1
5	FLAT HD MACH SCREW	Y#10-03	17090	2	48	*SUCT HD O-RING	25152-270	-----	1
6	SEAL CAVITY DRAIN/FILL PLUG	PC00004	17000	1	49	BONDED SEAL PLT	42111-066	24010	1
7	*SEAL RET RING	S00362	-----	1	50	STUD	C00611	17000	6
8	MOTOR CAVITY DRAIN PLUG	PC00004	17000	1	51	LOCKWASHER	J00006	17000	6
9	*MOTOR BUSHING	31173-017	23010	1	52	HEX NUT	D00006	17000	6
10	*LOWER BALL BEARING	S01834	-----	1	53	SEAL SPRING RETAINER	8793	17990	1
11	*BRG SNAP RING	S01831	-----	1	54	*IMPELLER KEY	N00302 1/2	17000	1
12	AL HD SETSCREW	GA00603	17000	1	55	NYLON LOCKNUT	BC00008-S	17000	1
13	SKCT HD PIPE PLUG	PC00004	17000	1	56	FLAT WASHER	KB00008	17090	1
14	NAME PLATE	2613-CY	17020	1	57	*IMP SHIM SET	2-Y	17090	REF
15	DRIVE SCREW	BM#04-03	17000	6	58	NYLOCK CAPSCREW	BT00806	17000	3
16	ROTOR	47112-806	-----	1	59	*SEAL SLEEVE	13878	17020	1
17	STATOR	47113-811	-----	1	60	*STRAINER	46611-006	24170	1
18	MOTOR HOUSING	38311-012	13040	1	61	HOISTING BAIL	31926-009	15031	1
19	*UPPER BALL BEARING	S01044	-----	1	62	HEX NUT	D00008	17000	2
20	*BRG SPRING WASHER	S01554	-----	1	63	STUD	C00806	17000	1
21	*DISC FLANGE GSKT	38687-045	20000	1	64	COUPLING NUT	31811-019	17000	1
22	DISC FLANGE	38641-006	13040	1	65	RELIEF VALVE ASSY	46431-608	-----	1
23	STUD	C00809	17000	3	66	INFORMATION PLATE	38816-047	17990	1
24	HEX NUT	D00008	17000	3	67	DRIVE SCREW	BM#04-03	17000	4
25	STUD	C00505	17000	4	68	MOTOR PLATE	10436	17000	1
26	HEX NUT	D00005	17000	4	69	DRIVE SCREW	BM#04-03	17000	4
27	LOCKWASHER	J00005	17000	4	NOT SHOWN:				
28	HVY PIPE NIPPLE	THA00608	15071	1	460V CONTROL BOX	47631-103	-----	1	
29	PIPE CAP	V00006	17000	1	CABLE TIE	27111-212	-----	1	
30	TERMINAL HOUSING	10757	13040	1	IMP PULLER ASSY	10285	-----	1	
31	TERMINAL GLAND	10756-B	13040	1	SUBMERSIBLE MOTOR	9568	-----	1	
32	CABLE ASSEMBLY	9166-F	-----	1	OIL - 1 QT				
33	STUD	C00606	17000	2	OPTIONAL:				
34	HEX NUT	D00006	17000	2	230V CONTROL BOX	47631-106	-----	1	
35	CABLE GRIP	11227-B	-----	1	STAGING ADAPTATION				
36	BUSHING	10758-F	19100	1	-DISCH FLANGE	38641-006	-----	1	
37	RD HD MACH SCREW	X#10-01 1/2	17000	1	-DISCH FLG GSKT	38687-045	-----	1	
38	T-TYPE LOCKWASHER	AK#00010	17000	1	REPAIR GASKET SET	11000-S	-----	1	
39	*TERM PLATE GSKT	10321-G	20000	1	LIQ LEVEL DEVICES:				
40	CONNECTOR	S01718	-----	4	DIAPHRAGM TYPE	GRP48-03 or GRP48-06	-----	1	
41	UPPER TERM PLATE	13880	23010	1	FLOAT TYPE	27471-155	-----	1	
42	*MOT LEAD BUSHING	13884	19140	1	LOW VOLT CONTROL	47631-502	-----	1	
43	LOWER TERM PLATE	13881	23010	1	24 VOLT				

*INDICATES PARTS RECOMMENDED FOR STOCK

Above Serial Numbers Do Not Apply To Pumps Made In Canada.

CANADIAN SERIAL NO AND UP

MAINTENANCE AND REPAIR

PUMP AND MOTOR DISASSEMBLY AND REASSEMBLY

The following maintenance and repair instructions are keyed to the sectional view (see Figure 1) and the accompanying parts list.

WARNING

```

////////////////////////////////////
//
// The electrical power to operate this pump is high enough //
// to cause injury or death. Make certain that the tie //
// handle on the control box is in the OFF position and //
// locked, or that the power supply to the control box has //
// been otherwise cut off and locked out, before attempting //
// to open or service the pump assembly. Tag electrical //
// circuits to prevent accidental start-up. //
// //
////////////////////////////////////

```

Before attempting to service the pump or control, cut off the power supply to the control box and close any valves in the discharge line.

WARNING

```

////////////////////////////////////
//
// Do not attempt to lift the pump by the motor power cable //
// or the piping. Attach proper lifting equipment to the //
// hoisting bail fitted to the pump. If chains or cable //
// are wrapped around the pump to lift it, make certain //
// that they are positioned so as not to damage pump, and //
// so that the load will be balanced. //
// //
////////////////////////////////////

```

Use the hoisting bail to lift the pump from the wet well or sump and move it to a location where the discharge line can be removed. If discharge hose is used with this pump, it is not necessary to disconnect the hose before removing the pump from the sump or wet well. If rigid discharge piping is used, disconnect the piping or the discharge flange (22) before attempting to remove the pump.

To remove the discharge flange, remove the nuts (24) securing the flange to the motor housing (18). Remove and discard the flange gasket (21).

Select a suitable location, preferably indoors, to perform the degree of maintenance required. If the motor housing is to be opened, the work must be done in a clean well-equipped shop. All maintenance functions must be performed by qualified personnel.

Check the chart in **TROUBLESHOOTING** to determine the nature of the pump problem. If the problem is mechanical in nature, such as worn pump parts, seal replacement, lubrication, etc., refer to **PUMP END DISASSEMBLY** for instructions.

If the problem is electrical, complete disassembly of the pump may not be required. Refer to **Electrical Testing** and have a qualified electrician check out control box, cable and terminal housing assembly. If problem is determined to be in the motor, proceed with **PUMP END DISASSEMBLY** followed by **MOTOR DISASSEMBLY**. Otherwise, see **Control Box and Terminal Housing And Cable Disassembly**.

All gaskets and most O-rings **must** be replaced if disturbed. A repair gasket kit is listed on the parts list as an option.

PUMP END DISASSEMBLY

Strainer Disassembly

To remove the strainer (60), raise the pump slightly or lay it on its side and remove nylock capscrew (58) securing the strainer to the suction head (1). If the impeller is clogged, the debris can usually be removed without further disassembly.

Draining Oil From Seal And Motor

After removing the strainer, the suction head (1) and impeller (2) may be serviced without draining the oil cavities. However, the oil should be drained before attempting to replace the shaft seals (3 and 4) or repair the motor.

CAUTION

Let the pump cool before removing the seal or motor cavity drain plug. Pressure built up within a hot pump could cause the oil to spray out when the plug is removed. Remove the plug slowly and permit pressure to vent to atmosphere.

Lay the pump on its side with the drain plugs (6 and 8) facing up, and clean any dirt from around the plugs. Remove the seal cavity drain/fill plug (6) and install a short 1/4-inch NPT nipple in the hole. Tip the pump up and drain the seal oil into a **clean** container. Inspect it for water, dirt or cloudy condition which could indicate lower seal failure or poor gasket seal.

If motor problems are suspected, remove motor cavity drain plug (8) and use a short nipple to drain the oil into a **clean** container at this time. Inspect the oil for dark color which could indicate motor overheating, dirt or water contamination. The presence of dirt or water could indicate a breakdown in the waterproof integrity of the motor cavity, probably due to poor gaskets or seals.

Use 'Loctite Pipe Sealant with Teflon 92' or equivalent compound on the threads of the drain plugs when reinstalling them.

Positioning Pump For Disassembly

It is recommended that the pump be positioned upside down during disassembly. To hold the pump in the inverted position, screw a pipe in the discharge flange

(22) and clamp it in a large vise. If the discharge flange has been removed, secure the discharge studs (23) to a bench or work stand. Be careful not to damage the terminal housing (30) or cable assembly (32) while in this position. Use adequate equipment and personnel to safely handle the pump until it is secured. If inverting the pump is not practical, lay the pump on its side and secure it.

Impeller Disassembly

After the strainer (60) has been removed, remove the hardware (52 and 51) securing the suction head (1) and seal plate (49) to the motor housing (18), and remove the suction head. Remove and discard the suction head O-ring (48).

Wedge a piece of wood between the vanes of the impeller (2) and the motor housing studs (50) to prevent shaft rotation. **Be careful** not to damage the rubber lining on the seal plate (49). Remove the impeller locknut (55) and the flat washer (56).

Remove the piece of wood from between the vanes of the impeller. Install the impeller puller supplied with the pump, and pull the impeller from the shaft. Retain the impeller key (54). Use caution when removing the impeller; tension on the seal spring will be released.

Remove the impeller adjusting shims (57); for ease of reassembly, tie and tag the shims.

Lower Seal Disassembly

(Figure 1 and 2)

Carefully remove the seal spring retainer (53) and spring. Remove the shaft sleeve (59), and work oil under the bellows assembly. Use a stiff wire with a hooked end to pull the rotating portion of the seal from the shaft.

To remove the stationary portion of the seal, remove the flat head machine screws (5) securing the seal plate (49) to the motor housing (18). Remove the seal plate, and remove and discard the seal plate O-ring (47). Place a **clean** cloth on a flat surface to protect the seal face of the stationary element, and place the seal plate on the cloth with the impeller side down. Use a drift pin or screwdriver to press on alternate sides of the stationary seat until the stationary element, seat and O-rings are removed.

The rotating and stationary seat elements are precision finished and subject to wear. The complete seal should be replaced with each overhaul to ensure trouble-free operation. However, if the old seal must be reused, wrap the seal faces individually in tissue paper to prevent damage to the sealing surfaces.

If no further disassembly is required, proceed to appropriate areas in **Pump End Reassembly**.

Upper Seal Disassembly

(Figure 1 and 2)

Unless cracked or otherwise worn, it is not necessary to remove the intermediate (46) for access to the upper seal assembly (4).

Remove the seal retaining ring (7) with snap ring pliers. Use caution when removing the snap ring; tension of the seal spring will be released. Remove the seal spring retainer and spring. Lubricate the rotor shaft adjacent to the seal, and work oil under the bellows. Use a stiff wire with a hooked end to pull the rotating portion of the seal off the shaft.

Slide the hooked ends of two wires along the shaft and under the stationary seal seat. Hook the back side of the seat and pull it from the intermediate.

NOTE

Do not disassemble the motor unless it is necessary and a clean, well-equipped shop is available. If the motor housing components are to be serviced, see **MOTOR DISASSEMBLY** in this section. Do not reassemble the pump end components at this time.

If no further disassembly is required, proceed to appropriate areas in **PUMP END REASSEMBLY**.

PUMP END REASSEMBLY

NOTE

Reuse of old O-rings, gaskets, or shaft seal parts may result in premature leakage or reduced pump performance. It is strongly recommended that an overhaul gasket kit and new shaft seal assemblies be used during reassembly (see the parts list for part numbers).

Cleaning Old Parts

With the pump inverted, stuff a clean tissue into the stationary seal seat bore of the intermediate (46) (or wrap a small rag around the shaft) to prevent foreign material from entering the motor cavity.

Carefully inspect O-rings or gaskets before removal and cleaning to determine if a proper seal and compression existed prior to disassembly. If sealing was faulty or questionable, the cause must be determined and corrected before reassembly. Replace any parts required.

Thoroughly clean all reuseable parts. Remove all O-rings and gaskets and clean the sealing surfaces of dirt or gasket material. Be careful not to scratch gasket surfaces.

MAINTENANCE AND REPAIR

WARNING

```

////////////////////////////////////
//
// Most cleaning solvents are toxic and flammable. Use //
// them only in a well-ventilated area free from excessive //
// heat, sparks, and flame. Read and follow all prec- //
// autions printed on solvent containers. //
// //
////////////////////////////////////

```

Neither of the shaft seal assemblies should be reused because wear patterns on the finished faces cannot be realigned during reassembly. This could result in premature failure. If necessary to reuse an old seal in an emergency, **carefully** wash all metallic parts in fresh cleaning solvent and allow to dry thoroughly.

Handle seal parts with extreme care to prevent damage. Be careful not to contaminate precision finished faces; even fingerprints on the faces can shorten seal life. If necessary, clean the faces with a non-oil based solvent and a clean lint free tissue. Wipe **lightly** in a concentric pattern to avoid scratching the faces.

Inspect the seal components for wear, scoring, grooves, and other damage that might cause leakage. If any components are worn, replace the complete seal; **never mix old and new seal parts.**

Inspect the end of the rotor shaft for damaged threads, scoring, and a nicked or damaged keyway. Remove nicks and burrs with a fine file or hand honing stone to restore original contours. If the shaft is bent or damaged, the complete shaft and rotor (16) must be replaced as an assembly (see **MOTOR DISASSEMBLY**).

Install the shaft seals as illustrated in Figure 2.

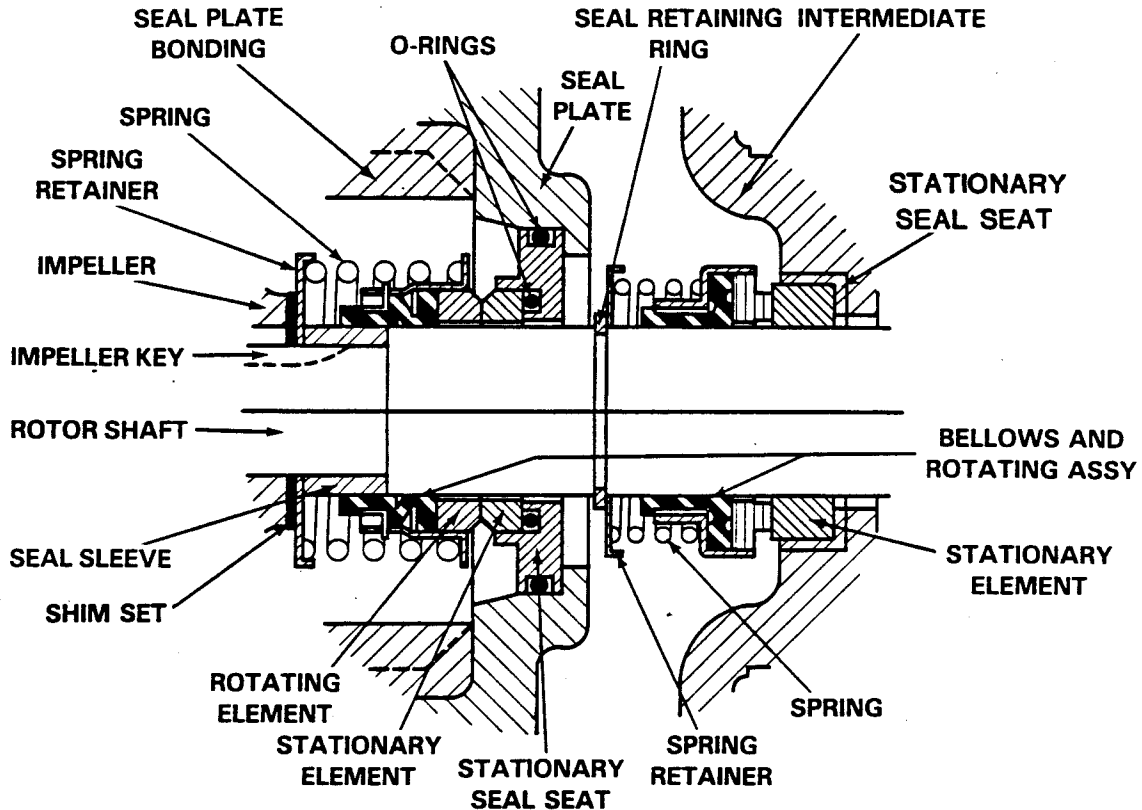

Figure 2. Seal Assemblies 25277-345 and S01832

Upper Seal Reassembly

If a new seal is to be installed, do not unwrap it until time of installation. Cleanliness of all seal components is a must, especially the seal faces.

Clean the rotor shaft and seal cavity area of the intermediate (46). Be sure the area is dry and free of lint and dirt.

Carefully remove the material stuffed into the seat bore (or unwrap the shaft). Be sure no debris stopped by the material falls into the motor cavity. Carefully clean the seal bore in the intermediate (46).

NOTE

When pressing seal components on the impeller shaft, use hand pressure only. A push tube cut from a length of plastic pipe will aid in installing seal components. The I.D. of the push tube should be approximately the same as the O.D. of the seal spring.

Unpack the stationary seal seat and stationary element, taking care not to touch sealing face. Apply a **light** coating of oil to the stationary seat bore. Keep the sealing face dry.

MAINTENANCE AND REPAIR

Position the stationary seat and element in the bore with the sealing face up and cover the sealing face with a clean tissue. Use your thumbs to press the assembly into the bore. Apply equal pressure on opposite sides until it contacts the bore shoulder. Remove the tissue and inspect the seal face to ensure that it is clean and dry. If cleaning is necessary, use clean tissue to wipe **lightly** in a concentric pattern.

Unpack the rotating portion of the seal. Be certain the seal face of the rotating element is free of grit or surface damage. Assemble the drive grooves of the rotating element into the drive lugs of the bellows retainer.

Apply a light coating of oil to the groove of the retaining ring (7) and I.D. of the bellows. Thoroughly lubricate the straight part of the shaft. Place the rotating seal portion on the shaft with seal face down. If the rotating element does not stay in the bellows retainer when turned upside down, place a **small** amount of grease at equal spaces on the back of the element and position it into the bellows retainer. The grease should hold the element in position until the seal is installed. Apply firm, steady pressure, with clean hands, on the seal retainer until it slides down the shaft and makes contact with the stationary element. This step should be done in one continuous motion to prevent the bellows from sticking or rolling as it passes over the retaining ring groove.

Slide the seal spring over the shaft and bellows retainer, and install the spring retainer. Install the seal retaining ring (7). See Figure 2 for proper order of seal assembly.

Lower Seal Reassembly

Inspect the seal plate (49) for cracks, distortion and erosion. Replace it if defective.

Clean the seal plate bore and O-ring surface. Lightly oil the O-ring (47), and install it on the seal plate. Align the seal plate machine screw holes (5) with the threaded holes in the motor housing (18), and install the seal plate over the motor housing studs (50) and onto the motor housing and intermediate (46). Secure the seal plate with the machine screws.

Thoroughly clean the shaft sleeve (59) and inspect it for nicks or cuts on the ends. Replace if defective.

NOTE

When pressing seal components on impeller shaft, use hand pressure only. A push tube cut from the length of plastic pipe will aid in installing seal components. The I.D. of the push tube should be approximately the same as the I.D. of the seal spring.

Unpack the stationary seat, and check that the O-rings are properly installed (see Figure 2). Apply a light coating of oil to the outer O-ring. Press the stationary seat into the seal bore until it bottoms squarely.

Place clean tissue over the sealing face of the stationary element and slide it over the rotor shaft. Press the element into the stationary seat, making sure that the grooves in the element fit into the drive lugs in the seat. Remove the tissue and inspect the seal face to ensure that it is clean and dry. If cleaning is necessary, use clean tissue to wipe lightly in a concentric direction.

Apply a light coating of oil to the O.D. of the shaft sleeve (59) and install it on the shaft with the chamfered end against the shaft shoulder.

Unpack the rotating portion of the seal. Be certain that seal face of the rotating element is free of grit or surface damage. Assemble the groove in the rotating element into the drive lug of the bellows retainer.

Apply a light coating of oil on the rotor shaft and the I.D. of the bellows. Place the rotating seal portion on shaft with seal face down. If the rotating element does not stay in the bellows retainer when turned upside down, place a **small** amount of grease at equal spaces on the back of the element and position it into the bellows retainer. The grease should hold the element in position until the seal is installed. Apply firm, steady pressure, with clean hands, on the bellows retainer until it slides down the shaft and the rotating element makes contact with the stationary element.

Slide the seal spring over the shaft and bellows retainer, and install the seal spring retainer (53).

Impeller Reassembly

Reinstall the same number of impeller shims (57) as originally removed.

Inspect the impeller (2), and replace it if cracked or worn.

Install the impeller key (54) in the rotor shaft keyway, align the impeller keyway, and push the impeller on the shaft until it seats firmly against the upper impeller washer and adjusting shims.

After the impeller has been installed, coat the threads of the rotor shaft with 'Never-Seez' or equivalent compound. Install the impeller washer (56) and nylon locknut (55). Wedge a block of wood between the impeller vanes and the motor housing studs (50) to prevent shaft rotation, and torque the nylon locknut to 60 ft. lbs. (720 inch lbs.).

Thoroughly clean the suction head (1) and its O-ring surface. Install the suction head O-ring (48), and install the suction head over the motor housing studs (50). Coat the threads of the studs with 'Never-Seez' or equivalent compound, and install the washers and nuts (51 and 52) securing the suction head and seal plate. Torque the nuts to 20 ft. lbs. (240 inch lbs.).

There should be a clearance of between .008 and .015 inches between the suction head and the face of the impeller. Reach into the suction head with a feeler gauge to measure this clearance.

If the impeller clearance is not within specified limits, remove the suction head and the impeller, then add or remove impeller adjusting shims (57) as required. Reinstall the impeller and suction head, and recheck clearance.

Strainer Reassembly

Inspect the strainer (60) for cracks, broken welds and distortion. Replace if defective. Install the strainer so that it seats properly against the shoulder of the suction head (1), and install the nylock capscrew (58) securing the strainer.

See LUBRICATION and FINAL ASSEMBLY before putting the pump into service.

MOTOR DISASSEMBLY

Disassembly of the motor is rarely required except to replace the motor rotor, stator, bearings, or intermediate. Do not disassemble the motor unless it is necessary and a clean, well-equipped shop is available.

NOTE

It is recommended that a pump with a defective motor be returned to Gorman-Rupp, or to one of the Gorman-Rupp authorized Submersible Repair Centers.

WARNING

```

////////////////////////////////////
//                               //
// The electrical power to operate this pump is high enough //
// to cause injury or death. Make certain that the tie //
// handle on the control box is in the OFF position and //
// locked, or that the power supply to the control box has //
// been otherwise cut off and locked out, before attempting //
// to open or service the pump assembly. Tag electrical //
// circuits to prevent accidental start-up. //
//                               //
////////////////////////////////////

```

Carefully inspect any O-rings or gaskets before removal and cleaning to determine if a proper seal and compression existed prior to disassembly. If sealing was faulty or questionable, the cause must be determined and corrected before reassembly. Replace any parts as required.

Terminal Housing And Power Cable Disassembly

If the pump is maintained in an upright position, the terminal housing and cable assembly (30 and 32) may be serviced without draining the oil from the motor cavity. However, the oil must be drained before attempting to disassemble the motor housing (18) and components. To drain the oil, see **Draining Oil** in **PUMP END DISASSEMBLY**.

Total disassembly of the terminal housing and power cable is not always required. Disassemble and replace only the parts which have been proven defective by inspection or testing. See **Electrical Testing** in **TROUBLESHOOTING**.

The terminal housing and power cable assembly may be serviced without disassembling the motor housing or pump end.

To remove the terminal housing (30), remove the nuts and washers (26 and 27) securing the terminal housing to the motor housing (18). Raise the terminal housing for access to the connectors (40), which are wrapped in underwater tape. Cut away the tape and remove the connectors. Remove the terminal housing and cable assembly.

MAINTENANCE AND REPAIR

To separate the power cable (32) from the terminal housing, remove the nuts (34) securing the terminal gland (31) to the terminal housing. Slide the gland back along the power cable. Compress the wire mesh of the cable grip (35) and move it back along power cable. Oil the gland bushing (36) and terminal housing bore and pull firmly on the cable. (Allow the oil to leak in around the bushing by agitating the cable in the bore). After the bushing has been loosened, the cable should pull out far enough to expose the gland bushing. Apply oil on the cable jacket and slide the bushing back along the cable. Quite often, pressure exerted on the bushing will deform the cable jacket. If such is the case, additional oil and effort will be required to remove the bushing.

NOTE

If the rubber bushing cannot be removed from the terminal housing as indicated, it may be necessary to cut the bushing into small pieces or cut the cable.

To disconnect the power cable, remove the round head screw (37) and lockwasher (38) securing the green ground lead. Pull the power cable out of the terminal housing. The gland bushing (36), cable grip (35) and terminal gland (31) can be removed from the cable.

For access to the motor connections, loosen the socket head capscrews (44), and pull the upper terminal plate (41), motor lead bushing (42), and and lower terminal plate (43) as an assembly over the motor leads.

See **Terminal Housing/Power Cable Reassembly** if no further disassembly is required.

Rotor Disassembly

See **Pump End Disassembly**, and remove all pump end components.

With the pump end disassembled and the motor cavity drained, grasp the threaded end of the rotor shaft and pull out the shaft and assembled intermediate (46), rotor (16) and bearings (10 and 19). Use caution to prevent the rotor from falling on the stator windings. Reach into the motor housing and remove the spring washer (20) from the upper bearing bore. Remove the motor bushing (9) from the motor housing.

If the motor shaft and assembled parts cannot be removed by hand, screw on the impeller locknut and use a commercial slide hammer puller to remove the assembly.

Pull the intermediate (46) from the lower ball bearing. Inspect the bearings (10 and 19). If rotation is rough or if the balls are discolored, remove the bearings from the rotor shaft. Use a bearing puller if necessary.

Stator Disassembly

It is recommended that the stator (17) be left in place unless it is defective. If the stator must be removed, disconnect the motor leads from the power cable leads as described in **Terminal Housing And Power Cable Disassembly**.

Remove the pipe plug (13) located in the motor housing, and loosen the allen head setscrew (12) located underneath the pipe plug.

Position an expandable tool, such as a split disc, approximately 2 inches down inside the stator, and expand the tool tightly and squarely on the I.D. Attach a lifting device to center lifting eye of the tool and raise the assembly one inch off floor. Take care not to damage the stator end turns. Use a soft-faced mallet to rap alternate edges of the motor housing (18), and "walk" the stator out. Continue this process until the stator clears the motor housing.

NOTE

It may be necessary to heat the motor housing to permit stator removal.

After the stator has been removed, wrap it in clean dry rags or other suitable material. The stator **must** be kept clean and dry. When handling the stator, do not set it on the end windings; lay it on its side.

CAUTION

Do not attempt to rewind the stator. Winding tolerances and materials are closely controlled by the manufacturer, and any deviation can cause damage or operating problems. Replace the stator, or return it to one of The Gorman-Rupp Authorized Submersible Repair Centers or The Gorman-Rupp factory, if defective.

Relief Valve

It is recommended that the relief valve assembly (65) be replaced at each overhaul, or at any time the pump motor overheats and activates the valve. Never replace this valve with a substitute which has not been specified or provided by the Gorman-Rupp Company.

When installing the relief valve, use "Loctite Pipe Sealant With Teflon #92" or equivalent compound on the threads.

Hoisting Bail

If the hoisting bail (61) requires replacement, loosen the hex nut (62) and coupling nut (64) securing the bail to the stud (63). Loosen the other hex nut (62) and unscrew the bail from the motor housing.

MOTOR REASSEMBLY

NOTE

Reuse of old O-rings, gaskets, or shaft seal parts may result in premature leakage or reduced pump performance. It is strongly recommended that an overhaul gasket kit and new shaft seal assembly be used during reassembly (see the parts list for parts numbers).

Stator Reassembly

Clean all gasket and O-ring surfaces completely, removing any old gasket and cement material. Inspect the sealing surfaces for burrs, nicks, and pits which could cause a poor seal. Replace parts as required.

Thoroughly clean the inside of the motor housing (18) with fresh solvent. The interior **must** be dry and free of dirt or lint.

WARNING

```

////////////////////////////////////
//
// Most cleaning solvents are toxic and flammable. Use //
// them only in a well-ventilated area free from excessive //
// heat, sparks, and flame. Read and follow all prec- //
// autions printed on solvent containers. //
// //
////////////////////////////////////

```

Do not unwrap the stator until the motor housing has been prepared for stator installation. The stator **must** be kept clean and dry. When handling stator, do not set it on its end windings. Lay it on its side.

Test the new stator as indicated in **Electrical Testing** in TROUBLESHOOTING to ensure that no damage has occurred during handling.

Position an expandable tool, such as a split disc, approximately 2 inches down inside the stator, and expand the tool tightly and squarely on the I.D. Attach a lifting device to center lifting eye of the tool and carefully lift the assembly. Take care not to damage the stator end turns. Slip a sleeve over the stator lead wires to prevent damage to them.

Invert the motor housing. Position the stator so that the leads are in line with the opening for the terminal housing, and carefully lower the stator into the motor housing. If the stator "cocks" in the motor housing, remove it and try again. If necessary, heat the motor housing with a torch to expand it enough for the stator to be installed; when heating the motor housing, **make certain** that the stator is clear to avoid damage to the windings. Apply heat evenly to the inside of the motor housing; excessive heat is not required. Be careful not to damage the stator lead insulation during reassembly.

After the stator is fully and squarely seated on the motor housing shoulder, remove the tool used for lifting, and tighten the allen head setscrew (12) securing the stator in place. Coat the threads of the pipe plug (13) with "Loctite

MAINTENANCE AND REPAIR

Pipe Sealant With Teflon #92" or equivalent sealant, and install the plug over the allen head setscrew.

Cover the motor housing with a clean, lint-free cloth while the rotor is being assembled.

Rotor Reassembly

Inspect the seal and bearing areas of the rotor shaft. Inspect the shaft for damaged threads, scoring, and a nicked or damaged keyway. Remove nicks and burrs with a fine file or honing stone. If the shaft is bent or damaged, replace the shaft and rotor (a single assembly).

Install the upper ball bearing (19) on the rotor shaft so that it seats squarely against the shaft shoulder. Install the bearing snap ring (11). Install the lower ball bearing (10) on the rotor shaft so that the loading groove faces the rotor, and press the bearing until it seats squarely against the snap ring.

CAUTION

When installing the bearings onto the shaft, NEVER press or hit against the outer race, balls, or ball cage. Press ONLY on the inner race.

Clean the ball bearing bores and all gasket and O-ring surfaces of the intermediate (46) and the motor housing (18), completely removing any old gasket and cement material. Inspect the sealing surfaces for burrs, nicks and pits which could cause a poor seal. Repair or replace as required.

WARNING

Most cleaning solvents are toxic and flammable. Use them only in a well-ventilated area free from excessive heat, sparks, and flame. Read and follow all precautions printed on solvent containers.

Install the spring washer (20) in the motor housing bearing bore.

Carefully ease the rotor and assembled ball bearings through the stator until the upper bearing (19) is firmly seated in the motor housing bearing bore.

Position the motor bushing (9) in the motor housing so that the two drain holes are aligned with the motor cavity drain plug (8). Install the intermediate O-ring (45), and lubricate the I.D. of the intermediate bearing bore.

Position the bearing bore of the intermediate (46) over the lower ball bearing (10) , and press the intermediate over the bearing until it seats squarely on the motor bushing and the shoulder of the motor housing (18). Use caution not to cut the O-ring (45).

Terminal Housing And Power Cable Reassembly

WARNING

```

////////////////////////////////////
//
// The electrical power used to operate this pump is high //
// enough to cause injury or death. Make certain that the //
// control handle on the control box is in the OFF position //
// and locked, or that the power supply to the control box //
// has been otherwise cut off and locked out. Tag elec- //
// trical circuits to prevent accidental start-up. Obtain //
// the services of a qualified electrician and refer to the //
// wiring diagrams in INSTALLATION to make all electrical //
// connections. //
// //
////////////////////////////////////

```

WARNING

```

////////////////////////////////////
//
// Refer to the wiring diagrams in INSTALLATION when recon- //
// necting motor and power leads and power cable leads. //
// //
////////////////////////////////////

```

Clean the exterior of the pump power cable with warm water and mild detergent, and check for obvious physical damage. Check the cable for continuity and insulation resistance (see **Electrical Testing** in **TROUBLESHOOTING**).

CAUTION

Do not attempt repairs except at either end of the power cable. Splicing is not recommended.

Lubricate the upper bore of the terminal housing (30), outside of the power cable (32), and bores of the terminal gland (31), cable grip (35) and gland bushing (36) for ease of assembly. Slide the terminal gland, cable grip, gland bushing and terminal housing on the power cable in that order (see Figure 1 to recheck order of assembly).

Work the cable components up the cable to allow approximately 3 ft. of cable to extend below the terminal housing. Temporarily tape the green ground wire to the cable.

If the terminal plates (41 and 43) and motor lead bushing (42) have been removed, lightly oil the motor leads and install them through the lower plate, bushing, and upper plate. Lubricate the bushing bore in the motor housing and the O.D. of the bushing. With the capscrews (44) loosened **but not removed**, push the bushing into the motor housing bore. Gently pull the motor leads to take up excess slack, and torque the capscrews to 4 ft. lbs. (48 inch lbs.).

WARNING

```

////////////////////////////////////
//
// Do not attempt to operate this pump unless the cable and //
// motor lead connections are properly sealed with underwa- //
// ter tape. Moisture entering the terminal housing could //
// cause a short circuit, resulting in death or injury to //
// personnel and/or damage the pump. //
// //
////////////////////////////////////

```

Tin the ends of each power cable and motor lead with solder to prevent fraying. Secure the power cable and motor leads with connectors (40). Use underwater tape (Gorman-Rupp P/N 18666-068 or equivalent) on all connectors. Run the tape between the conductors, then double back. Finish the assembly by stretching the tape and wrapping around the connector and conductors.

After the connectors have been taped, untape the green ground lead and slide the terminal housing (30) down the cable. Secure the ground lead to the terminal housing with the machine screw (37) and lockwasher (38); make sure the lead makes good contact with the housing.

Pull gently on the power cable to remove any excess length from within the terminal housing. Lubricate the upper bore of the terminal housing, and slide the gland bushing (36) into place. Compress the wire mesh of the cable grip (35) and slide it down the cable, making sure it comes in contact with the bushing. Slide the terminal gland (31) into place. Engage nuts (34) finger tight; do not tighten at this time.

Coat the threads of the studs (25) with 'Never-Seez' or equivalent compound, and secure the terminal housing to the motor housing with nuts (26) and lockwashers (27); torque the nuts to 11 ft. lbs. (132 inch lbs.). If required, twist the motor leads to remove excess slack. Tighten the nuts (34) drawing the terminal gland (31) down into the terminal bore. Do not overtighten the nuts and damage the terminal gland or hardware.

See LUBRICATION and FINAL ASSEMBLY.

LUBRICATION

Check the oil level in the seal cavity and motor housing before initial startup, after the first two weeks of operation, and every month thereafter.

NOTE

To accurately check the oil level the pump must be cool.

The grade of lubricant used is critical to the operation of this pump. Use premium quality hydraulic oil in the grade specified in Table 1.

Table 1. Pump Oil Specifications

Specifications	
Type	Premium high viscosity index, anti-wear hydraulic oil
Neutralization	0.52
Dielectric	26,000(min)
Pour point	-55°F
Recommended supplier	
Gulf Oil Company	Gulf Harmony HVI AW 26

Seal Cavity

Lay the pump on its side, remove the seal cavity drain/fill plug (6) in the intermediate (46), and add approximately 1 pint of the recommended grade hydraulic oil. Apply "Loctite Pipe Sealant With Teflon #92", or equivalent sealant, to the threads of the drain/fill plug, and reinstall and tighten the plug.

Motor Housing Cavity

With the pump in an upright position, remove the pipe cap (29) on top of the pump and add approximately 3 quarts of the recommended grade hydraulic oil. Apply 'Loctite Pipe Sealant With Teflon #92', or equivalent sealant, to the threads of the cap, and reinstall and tighten it. If the heavy pipe nipple (28) is removed, apply 'Loctite Retaining Compound 35 or 75' to the motor housing threads **only** of the pipe nipple before reinstalling it.

FINAL ASSEMBLY

If the discharge flange (22) has been separated from the motor housing, replace the gasket (21) and secure the flange with nuts (24).

Connect the discharge hose, and position the pump in the sump or wet well. If rigid discharge piping is used, connect the piping after the pump has been positioned. Open any valves in the discharge line.

**For U.S. and International Warranty Information,
Please Visit www.grpumps.com/warranty
or call:
U.S.: 419-755-1280
International: +1-419-755-1352**

**For Canadian Warranty Information,
Please Visit www.grcanada.com/warranty
or call:
519-631-2870**