

**INSTALLATION, OPERATION,
AND MAINTENANCE MANUAL**
WITH PARTS LIST



10 SERIES PUMPS

| MODEL |
|--------------|
| 14D1 - GX390 |

THE GORMAN-RUPP COMPANY • MANSFIELD, OHIO

GORMAN-RUPP OF CANADA LIMITED • ST. THOMAS, ONTARIO, CANADA Printed in U.S.A.

©Copyright by the Gorman-Rupp Company



The engine exhaust from this product contains chemicals known to the State of California to cause cancer, birth defects or other reproductive harm.

TABLE OF CONTENTS

| | |
|--|-------------------|
| INTRODUCTION | PAGE I – 1 |
| SAFETY - SECTION A | PAGE A – 1 |
| INSTALLATION – SECTION B | PAGE B – 1 |
| Pump Dimensions | PAGE B – 1 |
| PREINSTALLATION INSPECTION | PAGE B – 1 |
| POSITIONING PUMP | PAGE B – 2 |
| Lifting | PAGE B – 2 |
| Mounting | PAGE B – 2 |
| Clearance | PAGE B – 2 |
| SUCTION AND DISCHARGE PIPING | PAGE B – 2 |
| Materials | PAGE B – 2 |
| Line Configuration | PAGE B – 3 |
| Connections to Pump | PAGE B – 3 |
| Gauges | PAGE B – 3 |
| SUCTION LINES | PAGE B – 3 |
| Fittings | PAGE B – 3 |
| Strainers | PAGE B – 3 |
| Sealing | PAGE B – 3 |
| Suction Lines In Sumps | PAGE B – 3 |
| Suction Line Positioning | PAGE B – 4 |
| DISCHARGE LINES | PAGE B – 4 |
| Siphoning | PAGE B – 4 |
| Valves | PAGE B – 4 |
| Bypass Lines | PAGE B – 5 |
| OPERATION – SECTION C | PAGE C – 1 |
| PRIMING | PAGE C – 1 |
| STARTING | PAGE C – 1 |
| OPERATION | PAGE C – 1 |
| Lines With a Bypass | PAGE C – 1 |
| Lines Without a Bypass | PAGE C – 2 |
| Leakage | PAGE C – 2 |
| Liquid Temperature And Overheating | PAGE C – 2 |
| Strainer Check | PAGE C – 2 |
| Pump Vacuum Check | PAGE C – 2 |
| STOPPING | PAGE C – 2 |
| Cold Weather Preservation | PAGE C – 3 |
| TROUBLESHOOTING – SECTION D | PAGE D – 1 |
| PUMP MAINTENANCE AND REPAIR - SECTION E | PAGE E – 1 |
| STANDARD PERFORMANCE CURVE | PAGE E – 1 |
| PARTS LISTS: | |
| Pump Model | PAGE E – 3 |

TABLE OF CONTENTS
(continued)

| | |
|---|--------------------|
| Pump End Assembly | PAGE E – 5 |
| PUMP AND SEAL DISASSEMBLY AND REASSEMBLY | PAGE E – 6 |
| Suction Check Valve Disassembly | PAGE E – 6 |
| Back Cover Removal | PAGE E – 6 |
| Pump Casing Removal | PAGE E – 6 |
| Impeller Removal | PAGE E – 7 |
| Seal Removal and Disassembly | PAGE E – 7 |
| Seal Reassembly and Installation | PAGE E – 7 |
| Impeller Installation And Adjustment | PAGE E – 8 |
| Pump Casing Installation | PAGE E – 9 |
| Back Cover Installation | PAGE E – 9 |
| Suction Check Valve Installation | PAGE E – 9 |
| Final Pump Assembly | PAGE E – 9 |
| LUBRICATION | PAGE E – 10 |
| Seal Assembly | PAGE E – 10 |
| Engine | PAGE E – 10 |

INTRODUCTION

This Installation, Operation, and Maintenance manual is designed to help you achieve the best performance and longest life from your Gorman-Rupp pump.

This pump is a 10 Series, semi-open impeller, self-priming centrifugal model with a suction check

valve. It is close-coupled to a single cylinder Honda gasoline engine, Model GX390PX2. The pump is designed for handling dirty water containing specified entrained solids. The basic material of construction for wetted parts is aluminum, with ductile iron impeller and steel wearing parts.

If there are any questions regarding the pump or its application which are not covered in this manual or in other literature accompanying this unit, please contact your Gorman-Rupp distributor, or write:

The Gorman-Rupp Company
P.O. Box 1217
Mansfield, Ohio 44901-1217

or

Gorman-Rupp of Canada Limited
70 Burwell Road
St. Thomas, Ontario N5P 3R7

For information or technical assistance on the engine, contact the engine manufacturer's local dealer or representative.

The following are used to alert maintenance personnel to procedures which require special attention, to those which could damage equipment, and to those which could be dangerous to personnel:



Immediate hazards which WILL result in severe personal injury or death. These instructions describe the procedure required and the injury which will result from failure to follow the procedure.

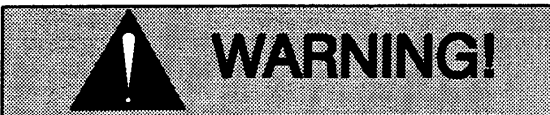

Hazards or unsafe practices which COULD result in severe personal injury or death. These instructions describe the procedure required and the injury which could result from failure to follow the procedure.



Hazards or unsafe practices which COULD result in minor personal injury or product or property damage. These instructions describe the requirements and the possible damage which could result from failure to follow the procedure.

NOTE

Instructions to aid in installation, operation, and maintenance or which clarify a procedure.

SAFETY – SECTION A

This information applies to 10 Series engine driven pumps. Refer to the manual accompanying the engine before attempting to begin operation.

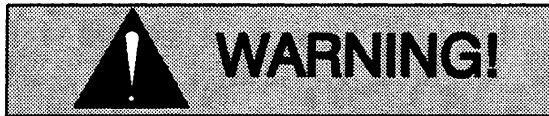

Before attempting to open or service the pump:

1. Familiarize yourself with this manual.
2. Shut down the engine and take precautions to ensure that the pump will remain inoperative.
3. Allow the pump to completely cool if overheated.
4. Check the temperature before opening any covers, plates, or plugs.
5. Close the suction and discharge valves.
6. Vent the pump slowly and cautiously.
7. Drain the pump.

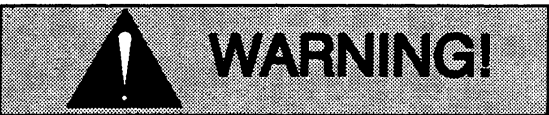

This pump is designed to handle dirty water containing specified entrained solids. Do not attempt to pump volatile, corrosive, or flammable liquids which may damage the pump or endanger personnel as a result of pump failure.

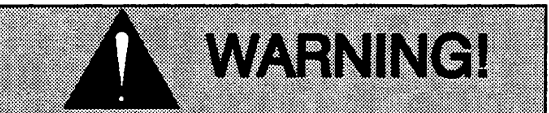

Use lifting and moving equipment in good repair and with adequate capacity to prevent injuries to personnel or dam-

age to equipment. Suction and discharge hoses and piping must be removed from the pump before lifting.

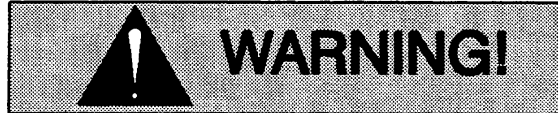

After the pump has been positioned, make certain that the pump and all piping connections are tight, properly supported and secure before operation.

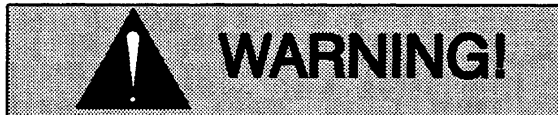

Do not operate the pump against a closed discharge valve for long periods of time. If operated against a closed discharge valve, pump components will deteriorate, and the liquid could come to a boil, build pressure, and cause the pump casing to rupture or explode.

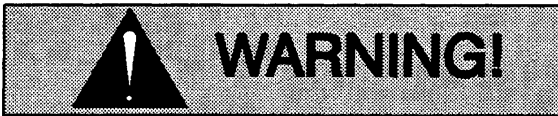

Do not remove plates, covers, gauges, pipe plugs, or fittings from an overheated pump. Vapor pressure within the pump can cause parts being disengaged to be ejected with great force. Allow the pump to cool before servicing.

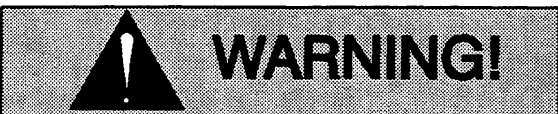

Do not operate an internal combustion engine in an explosive atmosphere. When operating internal combustion engines in an enclosed area, make certain that exhaust fumes are piped to the outside. These fumes contain carbon monoxide, a deadly gas that is colorless, tasteless, and odorless.



Fuel used by internal combustion engines presents an extreme explosion and fire hazard. Make certain that all fuel lines are securely connected and free of leaks. Never refuel a hot or running engine. Avoid overfilling the fuel tank. Always use the correct type of fuel.



Never tamper with the governor to gain more power. The governor establishes safe operating limits that should not be exceeded. The maximum continuous operating speed for this pump is 3100 RPM.

INSTALLATION – SECTION B

Review all SAFETY information in Section A.

Since pump installations are seldom identical, this section offers only general recommendations and practices required to inspect, position, and arrange the pump and piping.

Most of the information pertains to a standard **static lift** application where the pump is positioned above the free level of liquid to be pumped.

If installed in a **flooded suction** application where the liquid is supplied to the pump under pressure, some of the information such as mounting, line configuration, and priming must be tailored to the

specific application. Since the pressure supplied to the pump is critical to performance and safety, **be sure** to limit the incoming pressure to 50% of the maximum permissible operating pressure as shown on the pump performance curve (see Section E, Page 1).

For further assistance, contact your Gorman-Rupp distributor or the Gorman-Rupp Company.

Pump Dimensions

See Figure 1 for the approximate physical dimensions of this pump.

OUTLINE DRAWING

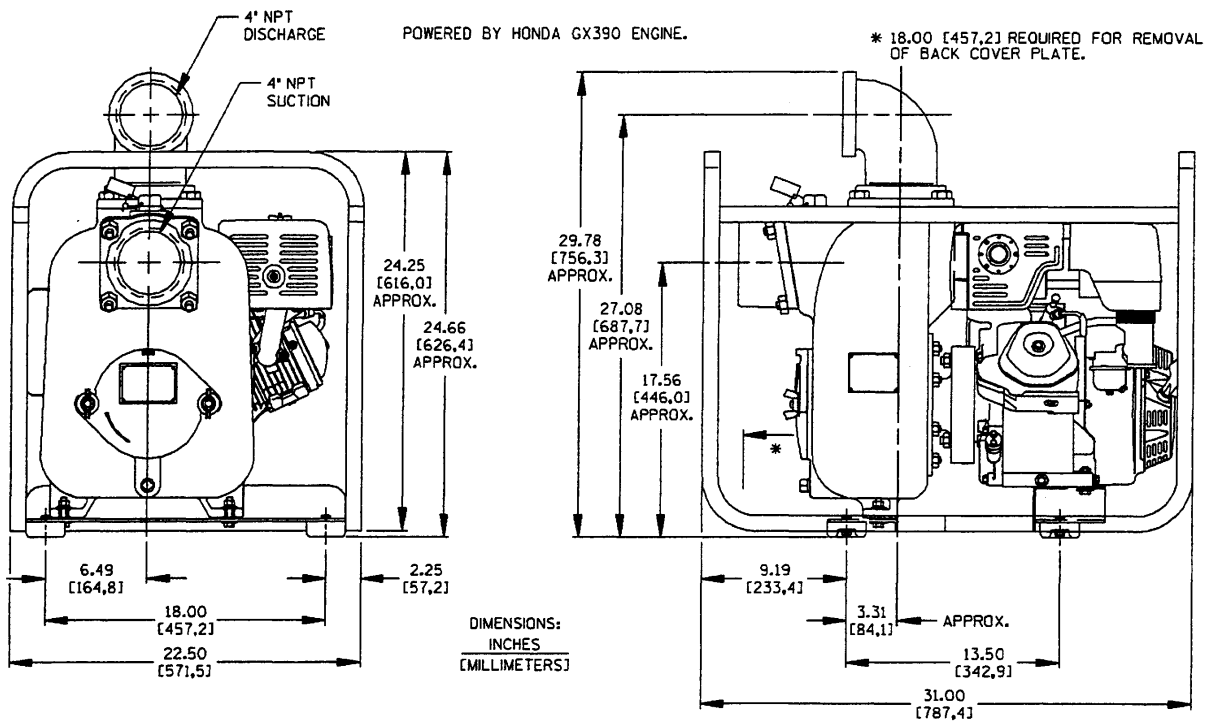

Figure 1. Pump Models 14D1-GX390

PREINSTALLATION INSPECTION

The pump assembly was inspected and tested before shipment from the factory. Before installation, inspect the pump for damage which may have occurred during shipment. Check as follows:

- a. Inspect the pump and engine for cracks, dents, damaged threads, and other obvious damage.
- b. Check for and tighten loose attaching hardware. Since gaskets tend to shrink after drying, check for loose hardware at mating surfaces.

- c. Carefully read all tags, decals, and markings on the pump assembly, and perform all duties indicated.
- d. Check levels and lubricate as necessary. Refer to **LUBRICATION** in the **MAINTENANCE AND REPAIR** section of this manual and perform duties as instructed.
- e. If the pump and engine have been stored for more than 12 months, some of the components or lubricants may have exceeded their maximum shelf life. These **must be inspected or replaced** to ensure maximum pump service.

If the maximum shelf life has been exceeded, or if anything appears to be abnormal, contact your Gorman-Rupp distributor or the factory to determine the repair or updating policy. **Do not** put the pump into service until appropriate action has been taken.

POSITIONING PUMP

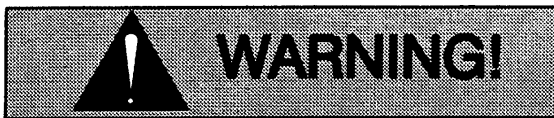

Use lifting and moving equipment in good repair and with adequate capacity to prevent injuries to personnel or damage to equipment. The bail is intended for use in lifting the pump assembly only. Suction and discharge hoses and piping must be removed from the pump before lifting.

Lifting

Use lifting equipment with a capacity of at least **920 pounds (417 kg.)**. The pump weighs approximately **184 pounds (83,4 kg.)** not including the weight of accessories or suction and discharge piping. Customer installed equipment such as suction and discharge piping **must be removed** before attempting to lift.

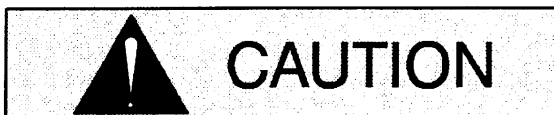

The pump assembly can be seriously

damaged if the cables or chains used to lift and move the unit are improperly wrapped around the pump.

Mounting

Locate the pump in an accessible place as close as practical to the liquid being pumped. Level mounting is essential for proper operation.

The pump may have to be supported or shimmed to provide for level operation or to eliminate vibration.

If the pump has been mounted on a moveable base, make certain the base is stationary by setting the brake and blocking the wheels before attempting to operate the pump.

To ensure sufficient lubrication and fuel supply to the engine, **do not** position the pump and engine more than 15° off horizontal for continuous operation. The pump and engine may be positioned up to 30° off horizontal for **intermittent operation only**; however, the engine manufacturer should be consulted for continuous operation at angles greater than 15° .

Clearance

When positioning the pump, allow a minimum clearance of **18 inches (457 mm)** in front of the back cover to permit removal of the cover and easy access to the pump interior.

SUCTION AND DISCHARGE PIPING

Pump performance is adversely effected by increased suction lift, discharge elevation, and friction losses. See the performance curve and notes on Page E-1 to be sure your overall application allows pump to operate within the safe operation range.

Materials

Either pipe or hose maybe used for suction and discharge lines; however, the materials must be compatible with the liquid being pumped. If hose is used in suction lines, it must be the rigid-wall, rein-

forced type to prevent collapse under suction. Using piping couplings in suction lines is not recommended.

Line Configuration

Keep suction and discharge lines as straight as possible to minimize friction losses. Make minimum use of elbows and fittings, which substantially increase friction loss. If elbows are necessary, use the long-radius type to minimize friction loss.

Connections to Pump

Before tightening a connecting flange, align it exactly with the pump port. Never pull a pipe line into place by tightening the flange bolts and/or couplings.

Lines near the pump must be independently supported to avoid strain on the pump which could cause excessive vibration, decreased bearing life, and increased shaft and seal wear. If hose-type lines are used, they should have adequate support to secure them when filled with liquid and under pressure.

Gauges

Most pumps are drilled and tapped for installing discharge pressure and vacuum suction gauges. If these gauges are desired for pumps that are not tapped, drill and tap the suction and discharge lines not less than 18 inches (457 mm) from the suction and discharge ports and install the lines. Installation closer to the pump may result in erratic readings.

SUCTION LINES

To avoid air pockets which could affect pump priming, the suction line must be as short and direct as possible. When operation involves a suction lift, the line must always slope upward to the pump from the source of the liquid being pumped; if the line slopes down to the pump at any point along the suction run, air pockets will be created.

Fittings

Suction lines should be the same size as the pump inlet. If reducers are used in suction lines, they should be the eccentric type, and should be installed with the flat part of the reducers uppermost to avoid creating air pockets. Valves are not normally used in suction lines, but if a valve is used, install it with the stem horizontal to avoid air pockets.

Strainers

If a strainer is furnished with the pump, be certain to use it; any spherical solids which pass through a strainer furnished with the pump will also pass through the pump itself.

If a strainer is not furnished with the pump, but is installed by the pump user, make certain that the total area of the openings in the strainer is at least three or four times the cross section of the suction line, and that the openings will not permit passage of solids larger than the solids handling capability of the pump.

This pump is designed to handle up to 2-inch (50,8 mm) diameter spherical solids.

Sealing

Since even a slight leak will affect priming, head, and capacity, especially when operating with a high suction lift, all connections in the suction line should be sealed with pipe dope to ensure an airtight seal. Follow the sealant manufacturer's recommendations when selecting and applying the pipe dope. The pipe dope should be compatible with the liquid being pumped.

Suction Lines In Sumps

If a single suction line is installed in a sump, it should be positioned away from the wall of the sump at a distance equal to 1-1/2 times the diameter of the suction line.

If there is a liquid flow from an open pipe into the sump, the flow should be kept away from the suction inlet because the inflow will carry air down into the sump, and air entering the suction line will reduce pump efficiency.

If it is necessary to position inflow close to the suction inlet, install a baffle between the inflow and the suction inlet at a distance 1-1/2 times the diameter of the suction pipe. The baffle will allow entrained air to escape from the liquid before it is drawn into the suction inlet.

If two suction lines are installed in a single sump, the flow paths may interact, reducing the efficiency of one or both pumps. To avoid this, position the suction inlets so that they are separated by a distance equal to at least 3 times the diameter of the suction pipe.

Suction Line Positioning

The depth of submergence of the suction line is critical to efficient pump operation. Figure 2 shows recommended minimum submergence vs. velocity.

NOTE

The pipe submergence required may be reduced by installing a standard pipe increaser fitting at the end of the suction line. The larger opening size will reduce the inlet velocity. Calculate the required submergence using the following formula based on the increased opening size (area or diameter).

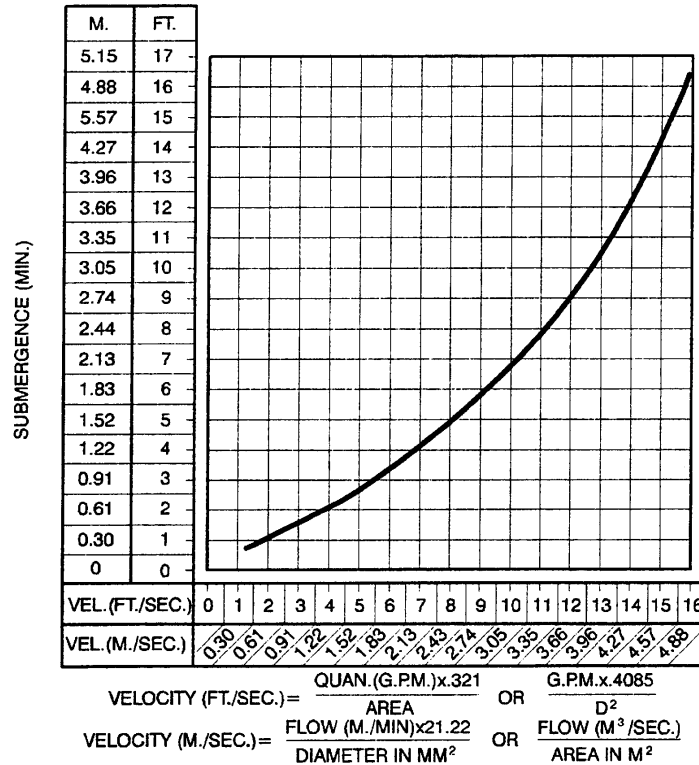

Figure 2. Recommended Minimum Suction Line Submergence vs. Velocity

DISCHARGE LINES

Siphoning

Do not terminate the discharge line at a level lower than that of the liquid being pumped unless a siphon breaker is used in the line. Otherwise, a siphoning action causing damage to the pump could result.

Valves

If a throttling valve is desired in the discharge line, use a valve as large as the largest pipe to minimize friction losses. Never install a throttling valve in a suction line.

A check valve in the discharge line is normally recommended, but it is not necessary in low discharge head applications.

With high discharge heads, it is recommended that a throttling valve and a system check valve be installed in the discharge line to protect the pump from excessive shock pressure and reverse rotation when it is stopped.



If the application involves a high discharge head, gradually close the discharge throttling valve before stopping the pump.

Bypass Lines

If a system check valve is used due to high discharge head, it may be necessary to vent trapped air from the top of the pump during the priming process. This may be accomplished by installing a bypass line from the top of the pump, back to the source of liquid. The end of the bypass line must be submerged. The line must be large enough to prevent clogging, but not so large as to affect pump discharge capacity.

OPERATION – SECTION C

Review all **SAFETY** information in Section A.

Follow the instructions on all tags, labels and decals attached to the pump.



This pump is designed to handle dirty water containing specified entrained solids. Do not attempt to pump volatile, corrosive, or flammable liquids which may damage the pump or endanger personnel as a result of pump failure.

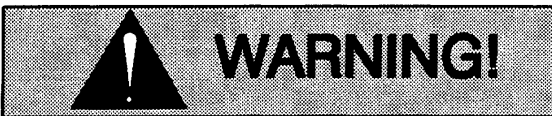

Never tamper with the governor to gain more power. The governor establishes safe operating limits that should not be exceeded. The maximum continuous operating speed for this pump is 3100 RPM.

PRIMING

Install the pump and piping as described in **INSTALLATION**. Make sure that the piping connections are tight, and that the pump is securely mounted. Check that the pump is properly lubricated (see **LUBRICATION** in **MAINTENANCE AND REPAIR**).

This pump is self-priming, but the pump should never be operated unless there is liquid in the pump casing.



Never operate this pump unless there is liquid in the pump casing. The pump will not prime when dry. Extended operation of a dry pump will destroy the seal assembly.

Add liquid to the pump casing when:

1. The pump is being put into service for the first time.
2. The pump has not been used for a considerable length of time.
3. The liquid in the pump casing has evaporated.

Once the pump casing has been filled, the pump will prime and reprime as necessary.

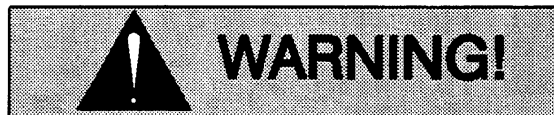

After filling the pump casing, reinstall and tighten the fill plug. Do not attempt to operate the pump unless all connecting piping is securely installed. Otherwise, liquid in the pump forced out under pressure could cause injury to personnel.

To fill the pump, remove the pump casing fill cover or fill plug in the top of the casing, and add clean liquid until the casing is filled. Replace the fill cover or fill plug before operating the pump.

STARTING

Consult the operations manual furnished with the engine.

OPERATION

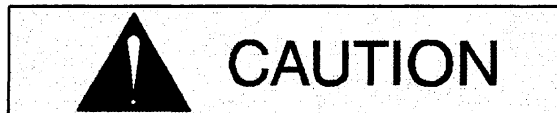

Pump speed and operating condition points must be within the continuous performance range shown on the curve. (See Section E, Page 1.)

Lines With a Bypass

Close the discharge throttling valve (if so equipped) so that the pump will not have to prime against the weight of the liquid in the discharge

line. Air from the suction line will be discharged through the bypass line back to the wet well during the priming cycle. When the pump is fully primed and liquid is flowing steadily from the bypass line, open the discharge throttling valve. Liquid will then continue to circulate through the bypass line while the pump is in operation.

Lines Without a Bypass

Open all valves in the discharge line and start the engine. Priming is indicated by a positive reading on the discharge pressure gauge or by a quieter operation. The pump may not prime immediately because the suction line must first fill with liquid. If the pump fails to prime within five minutes, stop it and check the suction line for leaks.

After the pump has been primed, partially close the discharge line throttling valve in order to fill the line slowly and guard against excessive shock pressure which could damage pipe ends, gaskets, sprinkler heads, and any other fixtures connected to the line. When the discharge line is completely filled, adjust the throttling valve to the required flow rate.

Leakage

No leakage should be visible at pump mating surfaces, or at pump connections or fittings. Keep all line connections and fittings tight to maintain maximum pump efficiency.

Liquid Temperature And Overheating

The **maximum** liquid temperature for this pump is 110° F (43° C). Do not apply it at a higher operating temperature.

Overheating can occur if operated with the valves in the suction or discharge lines closed. Operating against closed valves could bring the liquid to a boil, build pressure, and cause the pump to rupture or explode. If overheating occurs, stop the pump and allow it to cool before servicing it. Refill the pump casing with cool liquid.

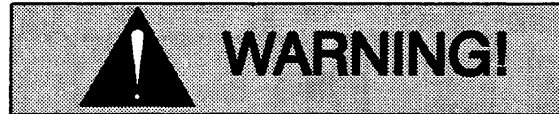

Do not remove plates, covers, gauges, pipe plugs, or fittings from an overheated pump. Vapor pressure within the pump can cause parts being disengaged to be ejected with great force. Allow the pump to cool before servicing.

Strainer Check

If a suction strainer has been shipped with the pump or installed by the user, check the strainer regularly, and clean it as necessary. The strainer should also be checked if pump flow rate begins to drop. If a vacuum suction gauge has been installed, monitor and record the readings regularly to detect strainer blockage.

Never introduce air or steam pressure into the pump casing or piping to remove a blockage. This could result in personal injury or damage to the equipment. If backflushing is absolutely necessary, **liquid pressure** must be limited to 50% of the maximum permissible operating pressure shown on the pump performance curve (see Section E, Page 1).

Pump Vacuum Check

With the pump inoperative, install a vacuum gauge in the system, using pipe dope on the threads. Block the suction line and start the pump. At operating speed the pump should pull a vacuum of 20 inches (508 mm) or more of mercury. If it does not, check for air leaks in the seal, gasket, or discharge valve.

Open the suction line, and read the vacuum gauge with the pump primed and at operation speed. Shut off the pump. The vacuum gauge reading will immediately drop proportionate to static suction lift, and should then stabilize. If the vacuum reading falls off rapidly after stabilization, an air leak exists. Before checking for the source of the leak, check the point of installation of the vacuum gauge.

STOPPING

Never halt the flow of liquid suddenly. If the liquid being pumped is stopped abruptly, damaging

shock waves can be transmitted to the pump and piping system. Close all connecting valves slowly.

On engine driven pumps, reduce the throttle speed slowly and allow the engine to idle briefly before stopping.



If the application involves a high discharge head, gradually close the discharge throttling valve before stopping the pump.

After stopping the pump, remove the engine ignition key to ensure that the pump will remain inoperative.

Cold Weather Preservation

In below freezing conditions, drain the pump to prevent damage from freezing. Also, clean out any solids by flushing with a hose. Operate the pump for approximately one minute; this will remove any remaining liquid that could freeze the pump rotating parts. If the pump will be idle for more than a few hours, or if it has been pumping liquids containing a large amount of solids, drain the pump, and flush it thoroughly with clean water. To prevent large solids from clogging the drain port and preventing the pump from completely draining, insert a rod or stiff wire in the drain port, and agitate the liquid during the draining process. Clean out any remaining solids by flushing with a hose.

TROUBLESHOOTING – SECTION D

Review all **SAFETY** information in Section A.

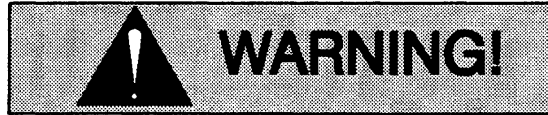

Before attempting to open or service the pump:

1. Familiarize yourself with this manual.
2. Shut down the engine and take precautions to ensure that the pump will remain inoperative.
3. Allow the pump to completely cool if overheated.
4. Check the temperature before opening any covers, plates, or plugs.
5. Close the suction and discharge valves.
6. Vent the pump slowly and cautiously.
7. Drain the pump.

| TROUBLE | POSSIBLE CAUSE | PROBABLE REMEDY |
|---------------------|---|---|
| PUMP FAILS TO PRIME | Not enough liquid in casing. Suction check valve contaminated or damaged. Air leak in suction line. Lining of suction hose collapsed. Leaking or worn seal or pump gasket. Suction lift or discharge head too high. Strainer clogged. | Add liquid to casing. See PRIMING . Clean or replace check valve. Correct leak. Replace suction hose. Check pump vacuum. Replace leaking or worn seal or gasket. Check piping installation and install bypass line if needed. See INSTALLATION . Check strainer and clean if necessary. |

| TROUBLE | POSSIBLE CAUSE | PROBABLE REMEDY |
|---|--|--|
| PUMP STOPS OR FAILS TO DELIVER RATED FLOW OR PRESSURE | <p>Air leak in suction line.</p> <p>Lining of suction hose collapsed.</p> <p>Leaking or worn seal or pump gasket.</p> <p>Suction intake not submerged at proper level or sump too small.</p> <p>Impeller or other wearing parts worn or damaged.</p> <p>Strainer clogged.</p> <p>Impeller clogged.</p> <p>Suction lift or discharge head too high.</p> | <p>Correct leak.</p> <p>Replace suction hose.</p> <p>Check pump vacuum. Replace leaking or worn seal or gasket.</p> <p>Check installation and correct submergence as needed.</p> <p>Replace worn or damaged parts. Check that impeller is properly centered and rotates freely.</p> <p>Check strainer and clean if necessary.</p> <p>Free impeller of debris.</p> <p>Check piping installation and install bypass line if needed. See INSTALLATION.</p> |
| PUMP REQUIRES TOO MUCH POWER | <p>Pump speed too high.</p> <p>Discharge head too low.</p> <p>Liquid solution too thick.</p> | <p>Check driver output; check that sheaves or couplings are correctly sized.</p> <p>Adjust discharge valve.</p> <p>Dilute if possible.</p> |
| PUMP CLOGS FREQUENTLY | <p>Discharge flow too slow.</p> <p>Suction check valve or foot valve clogged or binding.</p> <p>Discharge line clogged or restricted; hose kinked.</p> | <p>Open discharge valve fully to increase flow rate, and run engine at maximum governed speed.</p> <p>Clean valve.</p> <p>Check discharge lines; straighten hose.</p> |
| EXCESSIVE NOISE | <p>Cavitation in pump.</p> <p>Pumping entrained air.</p> <p>Pump or drive not securely mounted.</p> <p>Impeller clogged or damaged.</p> | <p>Reduce suction lift and/or friction losses in suction line. Record vacuum and pressure gauge readings and consult local representative or factory.</p> <p>Locate and eliminate source of air bubble.</p> <p>Secure mounting hardware.</p> <p>Clean out debris; replace damaged parts.</p> |

PUMP MAINTENANCE AND REPAIR - SECTION E

MAINTENANCE AND REPAIR OF THE WEARING PARTS OF THE PUMP WILL MAINTAIN PEAK OPERATING PERFORMANCE.

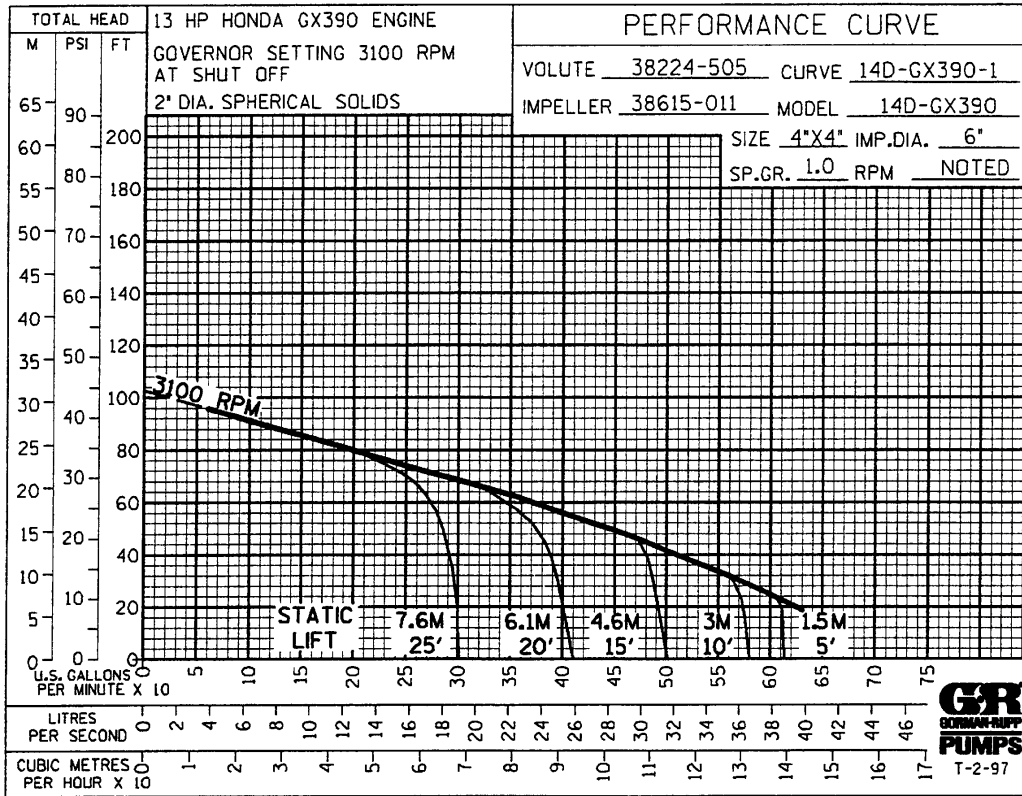

* STANDARD PERFORMANCE FOR PUMP MODELS 14D1 - GX390

* Based on 70° F (21° C) clear water at sea level with minimum suction lift. Since pump installations are seldom identical, your performance may be different due to such factors as viscosity, specific gravity, elevation, temperature, and impeller trim.

If your pump serial number is followed by an "N", your pump is **NOT** a standard production model. Contact the Gorman-Rupp Company to verify performance or part numbers.

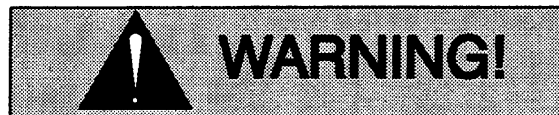

WARNING!

Never tamper with the governor to gain more power. The governor establishes safe operating limits that should not be exceeded. The maximum continuous operating speed for this pump is 3100 RPM.

SECTION DRAWING

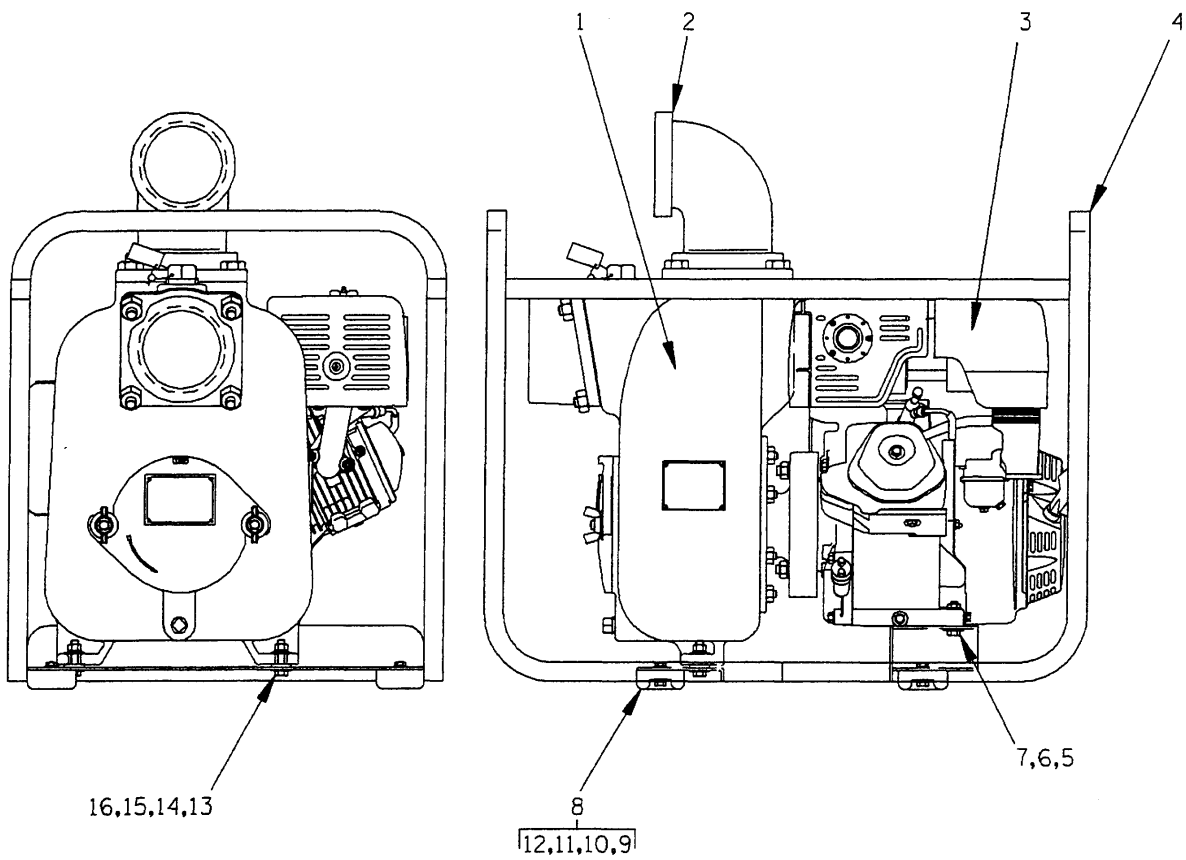

Figure 1. Pump Model 14D1 - GX390

PARTS LIST
Pump Models 14D1-GX390

(From S/N 1121294 up)

If your pump serial number is followed by an "N", your pump is **NOT** a standard production model. Contact the Gorman-Rupp Company to verify part numbers.

| ITEM NO. | PART NAME | PART NUMBER | MAT'L CODE | QTY |
|------------|---------------------|--------------|------------|-----|
| 1 | PUMP END ASSY | 14D1-(GX390) | --- | 1 |
| 2 | STREET ELBOW | RS64 | 11990 | 1 |
| 3 | HONDA GX390 ENGINE | 29122-036 | --- | 1 |
| 4 | ROLLOVER BASE | 41583-323 | 24150 | 1 |
| 5 | HEX HD CAPSCREW | B0606 | 15991 | 2 |
| 6 | FLANGED HEX NUT | 21765-314 | --- | 2 |
| 7 | FLAT WASHER | K06 | 15991 | 2 |
| 8 | RUBBER FOOT MTG KIT | 48152-603 | --- | 1 |
| 9 | -RUBBER FOOT | S1224 | --- | 4 |
| 10 | -FLAT WASHER | K05 | 15991 | 4 |
| 11 | -HEX HD CAPSCREW | B0504 | 15991 | 4 |
| 12 | -FLANGED HEX NUT | 21765-312 | --- | 4 |
| 13 | HEX HD CAPSCREW | B0606 | 15991 | 2 |
| 14 | LOCKWASHER | J06 | 15991 | 2 |
| 15 | FLAT WASHER | K06 | 15991 | 4 |
| 16 | HEX NUT | D06 | 15991 | 2 |
| NOT SHOWN: | | | | |
| | WARNING DECAL | 2613FE | --- | 1 |
| | HAND CARRY DECAL | 2613FT | --- | 4 |

Above Serial Numbers Do Not Apply To Pumps Made In Canada.

CANADIAN SERIAL NO. AND UP

SECTION DRAWING

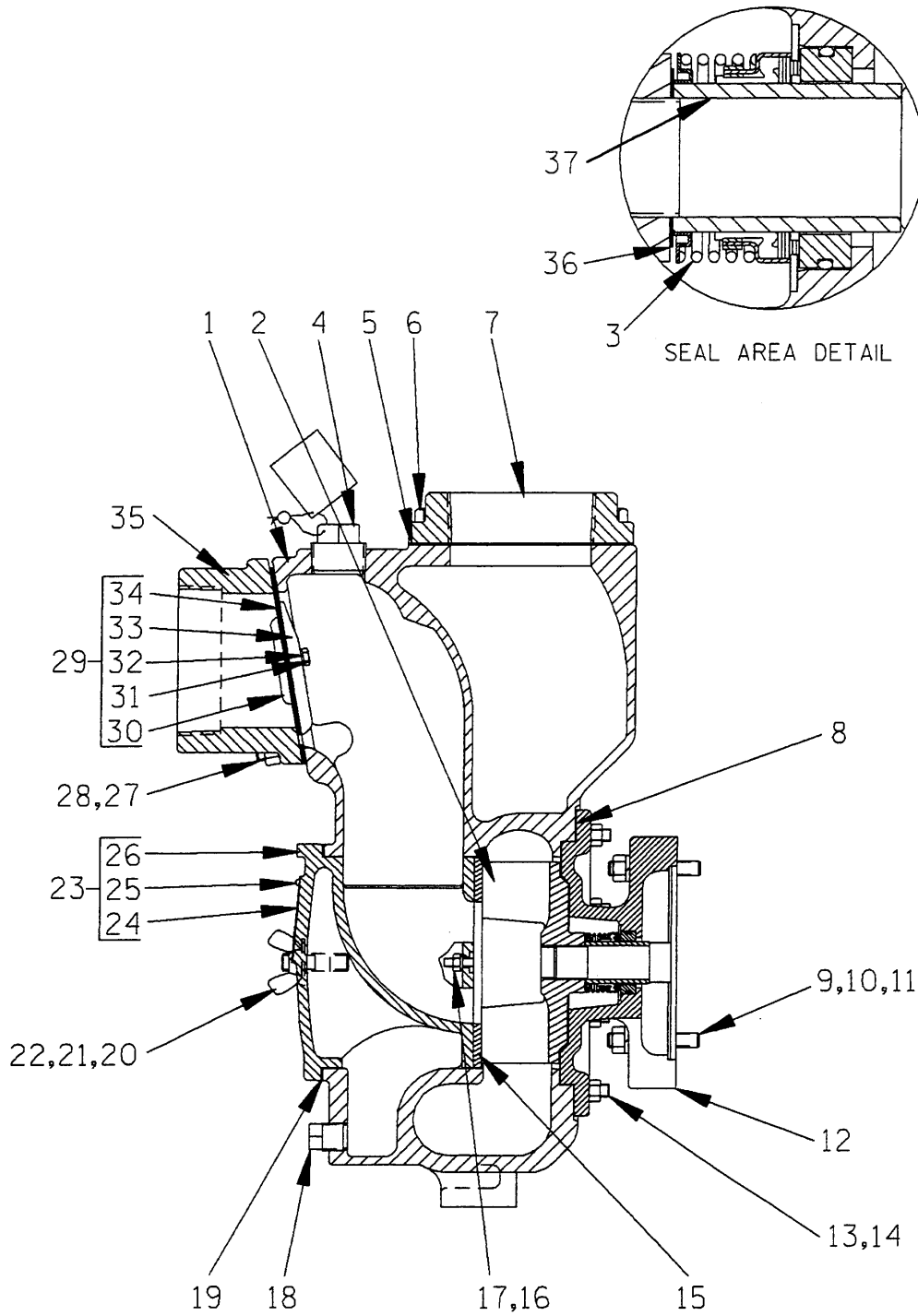

Figure 2. Pump End Assembly 14D1-(GX390)

PARTS LIST
Pump End Assembly 14D1 - (GX390)

| ITEM NO. | PART NAME | PART NUMBER | MAT'L CODE | QTY | ITEM NO. | PART NAME | PART NUMBER | MAT'L CODE | QTY |
|----------|-------------------|-------------|------------|-----|------------|---------------------|---------------|------------|-----|
| 1 | PUMP CASING | 38224-505 | 13040 | 1 | 22 | WING NUT | BB08 | 15991 | 2 |
| 2 * | IMPELLER | 38615-011 | 10010 | 1 | 23 | BACK CVR PLATE ASSY | 42111-937 | ---- | 1 |
| 3 * | MECH SEAL ASSY | 25284-951 | ---- | 1 | 24 | -NAME PLATE | 2613EV | 13990 | 1 |
| 4 | FILL PLUG ASSY | 48271-065 | ---- | 1 | 25 | -DRIVE SCREW | BM#04-03 | 17000 | 4 |
| 5 | GASKET | 38687-009 | 20000 | 1 | 26 | -BACK CVR PLATE | NOT AVAILABLE | | 1 |
| 6 | HEX HD CAPSCREW | B1005 | 15991 | 4 | 27 | STUD | C0808 | 15991 | 4 |
| 7 | DISCHARGE FLANGE | 38644-506 | 13000 | 1 | 28 | HEX NUT | D08 | 15991 | 4 |
| 8 * | CASING GASKET SET | 48211-022 | ---- | 1 | 29 | FLAP VALVE ASSY | 46413-029 | ---- | 1 |
| 9 | STUD | C0610 | 15991 | 4 | 30 | -SMALL VALVE WEIGHT | 19 | 10010 | 1 |
| 10 | LOCKWASHER | J06 | 15991 | 4 | 31 | -HEX HD CAPSCREW | B0403-1/2 | 17000 | 2 |
| 11 | HEX NUT | D06 | 15991 | 4 | 32 | -LOCKWASHER | J04 | 17000 | 2 |
| 12 | INTERMEDIATE | 38264-323 | 13000 | 1 | 33 | -LARGE VALVE WEIGHT | 4718 | 10010 | 1 |
| 13 | STUD | C0606 | 15991 | 8 | 34 * | -FLAP VALVE GASKET | 38671-626 | 19070 | 1 |
| 14 | HEX NUT | D06 | 15991 | 8 | 35 | SUCTION FLANGE | 38645-506 | 13000 | 1 |
| 15 * | WEAR PLATE ASSY | 46451-302 | 24150 | 1 | 36 * | IMP ADJ SHIM SET | 2X | 17090 | REF |
| 16 | LOCKWASHER | J04 | 15991 | 2 | 37 * | SHAFT SLEEVE | 2146M | 16000 | 1 |
| 17 | HEX NUT | D04 | 15991 | 2 | NOT SHOWN: | | | | |
| 18 | PIPE PLUG | P08 | 15079 | 1 | | NAME PLATE | 38818-021 | 13990 | 1 |
| 19 | BACK COVER GASKET | 38682-015 | 20000 | 1 | | DRIVE SCREW | BM#04-03 | 17000 | 4 |
| 20 | STUD | C0808 | 15991 | 2 | | STRAINER | 2690 | 24000 | 1 |
| 21 | FLAT WASHER | K08 | 15991 | 2 | | SUCTION STICKER | 6588AG | ---- | 1 |
| | | | | | | DISCHARGE STICKER | 6588BJ | ---- | 1 |

* INDICATES PARTS RECOMMENDED FOR STOCK

PUMP AND SEAL DISASSEMBLY AND REASSEMBLY

Review all SAFETY information in Section A.

Follow the instructions on all tags, label and decals attached to the pump.

This pump requires little service due to its rugged, minimum-maintenance design. However, if it becomes necessary to inspect or replace the wearing parts, follow these instructions which are keyed to the sectional views (see Figures 1 and 2) and the accompanying parts lists.

Before attempting to service the pump, shut down the engine and disconnect the spark plug wire to ensure that it will remain inoperative. Close all valves in the suction and discharge lines.

For engine disassembly and repair, consult the literature supplied with the engine, or contact your local Honda engine representative.

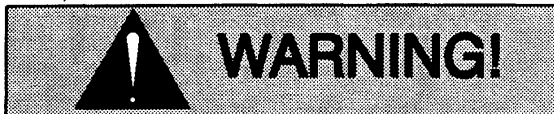

Before attempting to open or service the pump:

1. Familiarize yourself with this manual.
2. Shut down the engine and disconnect the spark plug wire to ensure that the pump will remain inoperative.
3. Allow the pump to completely cool if overheated.
4. Check the temperature before opening any covers, plates, or plugs.
5. Close the suction and discharge valves.
6. Vent the pump slowly and cautiously.
7. Drain the pump.

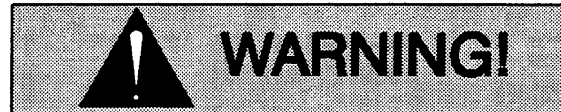

Use lifting and moving equipment in good repair and with adequate capacity to prevent injuries to personnel or damage to equipment. Suction and discharge hoses and piping must be removed from the pump before lifting.

Suction Check Valve Disassembly

(Figure 2)

Before attempting to service the pump, remove the pump casing drain plug (18) and drain the pump. Clean and reinstall the drain plug.

To service the suction check valve, remove the suction piping. Remove the nuts (5) securing the suction flange (35) to the pump casing (1). Pull the check valve assembly (29) from the suction port.

Remove the hardware (31 and 32) securing the check valve weights (30 and 33) to the check valve (34).

If no further disassembly is required, see **Suction Check Valve Installation**.

Back Cover Removal

(Figure 2)

The wear plate assembly (15) can be serviced after the back cover assembly (23) has been removed.

Remove the wing nuts and flat washers (21 and 22) securing the back cover to the casing. Pull the back cover and assembled wear plate from the pump casing. Remove the cover plate gasket (19) and clean the mating surfaces.

Inspect the wear plate and if replacement is required, remove the hardware (16 and 17) securing it to the back cover.

Pump Casing Removal

(Figure 2)

To service the impeller or seal assembly, disconnect the discharge piping. See Figure 1 and remove the hardware (12, 13, 14 and 15) securing the pump casing to the base (3).

Support the pump casing (1) using a suitable hoist and sling, and remove the nuts (14) securing the pump casing to the intermediate (12). Separate the parts by pulling the casing straight away from the intermediate. If shims have been used under the mounting feet to level the pump casing, tie and tag these shims for ease of reassembly.

Remove the casing gasket set (8). Record the thickness of the gaskets for future reference. Clean the mating surfaces of the intermediate and pump casing.

Impeller Removal

(Figure 2)

To loosen the impeller (2), tap the vanes of the impeller in a counterclockwise direction (when facing the impeller) with a block of wood or a soft-faced mallet. Unscrew the impeller and replace it if cracked or badly worn. Use caution when removing the impeller; tension on the seal spring will be released as the impeller is unscrewed.

Slide the impeller adjusting shims (36) off the impeller shaft. Tie and tag the shims or measure and record their thickness for ease of reassembly.

Seal Removal and Disassembly

(Figures 2 and 3)

Remove the spring centering washer and seal spring. Slide the shaft sleeve (37) and rotating portion of the seal off the shaft as an assembly. Lubricate the sleeve adjacent to the seal and work oil up under the rubber bellows. Slide the rotating portion of the seal off the shaft sleeve.

Remove the hardware (10 and 11) and carefully slide the intermediate (12) and stationary portion of the seal off the shaft as a unit. Use a suitably sized dowel to press the stationary element out of the intermediate from the back side.

NOTE

The seal assembly may be removed without completely disassembling the pump by using a pair of stiff wires with hooked ends to pull the seal stationary seat out of the intermediate.

If no further disassembly is required, see **Seal Reassembly and Installation**.

Seal Reassembly and Installation

(Figures 1 and 3)

Clean the seal cavity and shaft with a cloth soaked in fresh cleaning solvent.

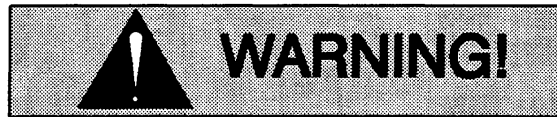

Most cleaning solvents are toxic and flammable. Use them only in a well ventilated area free from excessive heat, sparks, and flame. Read and follow all precautions printed on solvent containers.

The seal is not normally reused because wear patterns on the finished faces cannot be realigned during reassembly. This could result in premature failure. If necessary to reuse an old seal in an emergency, **carefully** wash all metallic parts in **fresh** cleaning solvent and allow to dry thoroughly.

Handle the seal parts with extreme care to prevent damage. Be careful not to contaminate precision finished faces; even fingerprints on the faces can shorten seal life. If necessary, clean the faces with a non-oil based solvent and a clean, lint-free tissue. Wipe **lightly** in a concentric pattern to avoid scratching the faces.

Inspect the seal components for wear, scoring, grooves, and other damage that might cause leakage. Clean and polish the shaft sleeve, or replace it if there are nicks or cuts on either end. If any components are worn, replace the complete seal; **never mix old and new seal parts.**

If a replacement seal is being used, remove it from the container and inspect the precision finished faces to ensure that they are free of any foreign matter.

To ease installation of the seal, lubricate the O-rings, sleeve and bellows with water or a very **small** amount of oil, and apply a drop of light lubricating oil on the finished faces. Assemble the seal as follows, (see Figure 3).

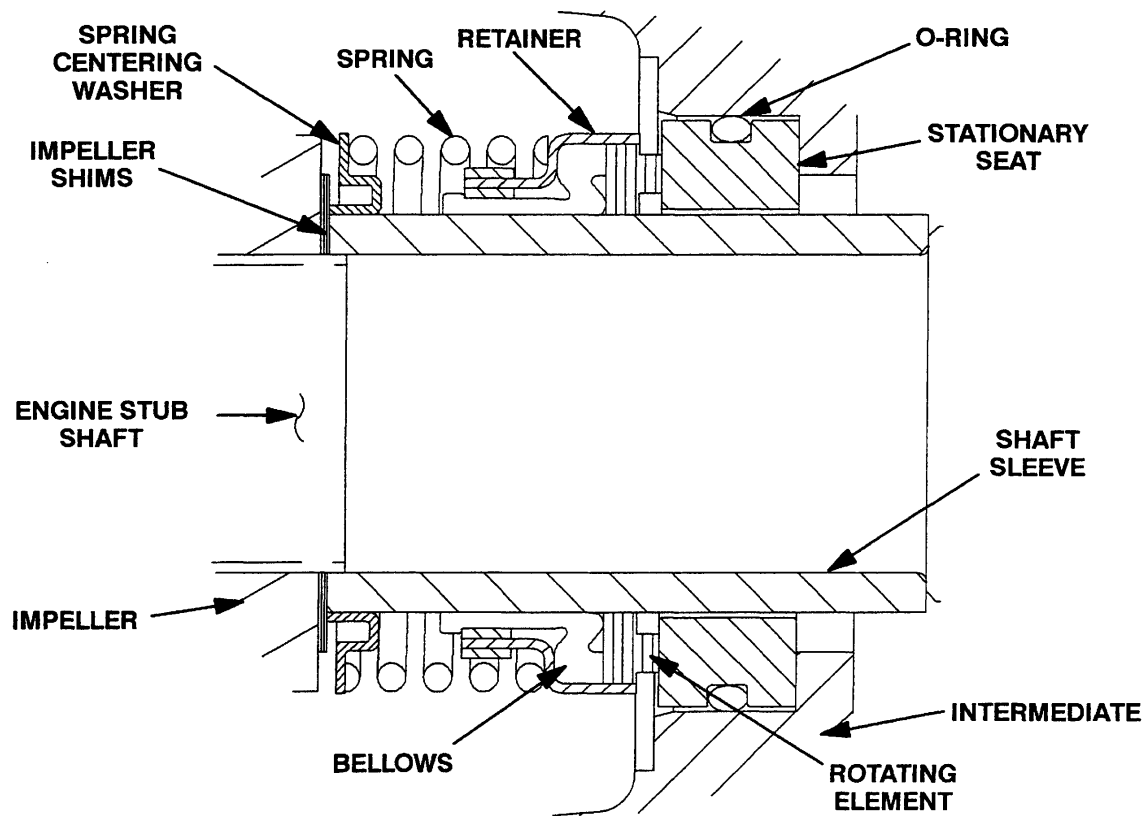
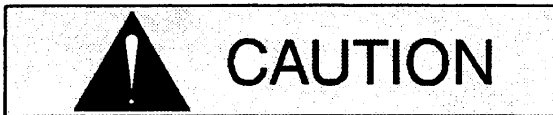

Figure 4. 25284-951 Seal Assembly



This seal is not designed for operation at temperatures above 160°F (71°C). Do not use at higher operating temperatures.

Inspect the engine stub shaft for damage. Small scratches or nicks may be removed with a fine file or emery cloth. If the stub shaft is bent or excessively worn, replace the shaft (see the engine service manual).

Position the intermediate against the engine bell-housing and secure it with hardware (10 and 11).

Assemble the O-ring into the stationary seat. Press the stationary seat into the intermediate bore until fully seated. A push tube cut from a length of plastic pipe would aid this installation. The I.D. of the tube should be approximately the same as the I.D. of the seal spring.

Subassemble the rotating element into the retainer and bellows. Apply a drop of light oil on the precision finished faces; **never use grease**. Use even pressure to carefully press this subassembly onto the sleeve (37) until the rotating element is just flush with the chamfered end of the sleeve.

Slide the sleeve and assembled rotating portion of the seal onto the shaft until the seal faces contact. Continue to push the sleeve through the seal until it seats squarely against the shaft shoulder.

Install the seal spring and spring centering washer.

Lubricate the seal as indicated in **LUBRICATION**, after the impeller has been installed.

Impeller Installation And Adjustment

(Figure 2)

Inspect the impeller and replace it if cracked or badly worn. Install the same thickness of impeller shims (21) as previously removed and screw the impeller onto the shaft until tight.

A clearance of .020 to .040 inch (0,51 to 1,02 mm) between the impeller and the intermediate is necessary for maximum pump efficiency. Measure this clearance and add or remove impeller shims until this clearance is reached.

Pump Casing Installation

(Figure 2)

Install the same thickness of pump casing gaskets (8) as previously removed and secure the pump casing (1) to the intermediate with the nuts (14). **Do not** fully tighten the nuts at this time.

A clearance of .008 to .015 inch (0,20 to 0,38 mm) between the impeller and the wear plate is also recommended for maximum pump efficiency. Install the back cover and set this clearance by adding or removing gaskets in the pump casing gasket set until the impeller scrapes against the wear plate when the shaft is turned. After the impeller scrapes, add approximately .015 inch (0,38 mm) of gaskets and fully tighten the nuts (14).

NOTE

An alternate method of adjusting this clearance is to reach through the discharge port with a feeler gauge and measure the gap. Add or subtract pump casing gaskets accordingly.

See Figure 1 and secure the pump casing to the base (3) with the hardware (12, 13, 14 and 15). Be sure to reinstall any leveling shims used under the mounting feet of the pump casing.

Back Cover Installation

(Figure 2)

Inspect the wear plate (15) and replace it if badly worn or grooved. Install the wear plate on the back cover using the hardware (16 and 17).

Clean any scale or debris from the back cover shoulder and pump casing which might prevent a good seal.

NOTE

Apply a film of 'Never-Seez' or equivalent com-

pound on the back cover shoulder or any surface which contacts the pump casing to ease future dis-assembly and to reduce rust and scale build up.

Replace the back cover gasket (19) and slide the back cover assembly (23) into the pump casing. Be sure the wear plate does not scrape against the impeller.

Secure the back cover assembly to the pump casing using the hardware (21 and 22). **Do not** over tighten the wing nuts; they should be just tight enough to ensure a good seal at the back cover shoulder.

Suction Check Valve Installation

(Figure 2)

Inspect the check valve components and replace as required. Subassemble the check valve weights (30 and 33) and check valve gasket (34) with the hardware (31 and 32).

Position the check valve assembly (29) in the suction port with the large weight (33) facing toward the inside of the pump casing. Install the suction flange (35) and secure with the nuts (28). Check the operation of the check valve to ensure proper seating and free movement.

Final Pump Assembly

(Figure 1)

Be sure the pump and engine are securely mounted to the base.

Install the suction and discharge lines and open all valves. Make certain that all piping connections are tight, properly supported and secure.

Be sure the engine has been properly lubricated, see **LUBRICATION**.

Remove the fill plug assembly (4). Fill the pump casing with clean liquid. Reinstall the fill plug and tighten it.

Refer to **OPERATION**, Section C, before putting the pump back into service.

LUBRICATION**Seal Assembly
(Figure 2)**

The seal assembly is lubricated by the medium being pumped. No additional lubrication is required.

Engine

Consult the literature supplied with the engine, or contact your local Honda engine representative.

**For U.S. and International Warranty Information,
Please Visit www.grpumps.com/warranty
or call:
U.S.: 419-755-1280
International: +1-419-755-1352**

**For Canadian Warranty Information,
Please Visit www.grcanada.com/warranty
or call:
519-631-2870**