



## Basic Pedestal

# Standard Centrifugal Pump

## Model VG1 1/2D3-B

### Size 2 1/2" x 1 1/2"

#### PUMP SPECIFICATIONS

**Size:** 2 1/2" x 1 1/2" (64 mm x 38 mm) Flanged.

**Casing:** Gray Iron 40.

Maximum Operating Pressure 241 psi (1662 kPa).\*

**Enclosed Type, Six Vane Impeller:** Gray Iron 40.

Handles 5/16" (7,9 mm) Diameter Spherical Solids.

**Impeller Shaft:** Steel 1045.

**Shaft Sleeve:** Stainless Steel 420.

**Seal Plate:** Gray Iron 40.

**Bearing Housing:** Gray Iron 40.

**Radial Bearing:** Open Single Row Ball.

**Thrust Bearing:** Open Double Row Ball.

**Bearing Lubrication:** SAE 30 Non-Detergent Oil.

**Gaskets:** Nitrile Rubber.

**O-Ring:** Fluorocarbon (DuPont Viton® or Equivalent).

**Hardware:** Standard Plated Steel.

**Oil Level Sight Gauge.**

**Optional Equipment:** NPT Suction and Discharge Flanges. Strainer. Stainless Steel Impeller. Mechanical Seal with Fluorocarbon Elastomers (DuPont Viton® or Equivalent).

*\*Consult Factory for Applications Exceeding Maximum Pressure and/or Temperature Indicated.*

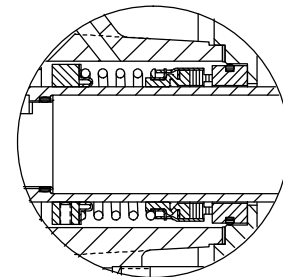
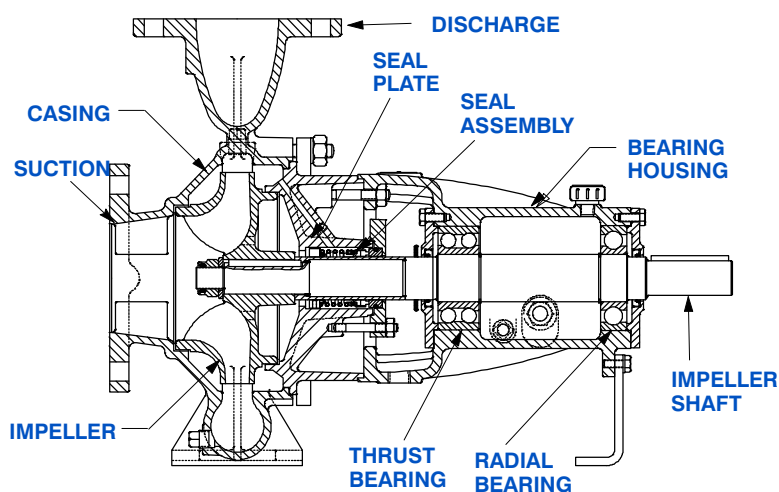

#### SEAL DETAIL

Type 1, Mechanical, Self-Lubricated. Carbon Rotating Face. Ceramic Stationary Seat. Buna-N Elastomers. Stainless Steel and/or Brass Cage and Spring. Maximum Temperature of Liquid Pumped, 160°F (71°C).\*



## GORMAN-RUPP PUMPS

www.grpumps.com

Specifications Subject to Change Without Notice

Printed in U.S.A.

**Specification Data**

SECTION 70, PAGE 160

APPROXIMATE  
DIMENSIONS and WEIGHTS

**NET WEIGHT: 107 LBS. (48,5 KG.)**  
**SHIPPING WEIGHT: 117 LBS. (53,1 KG.)**  
**EXPORT CRATE SIZE: 5.6 CU. FT. (0,16 CU. M.)**

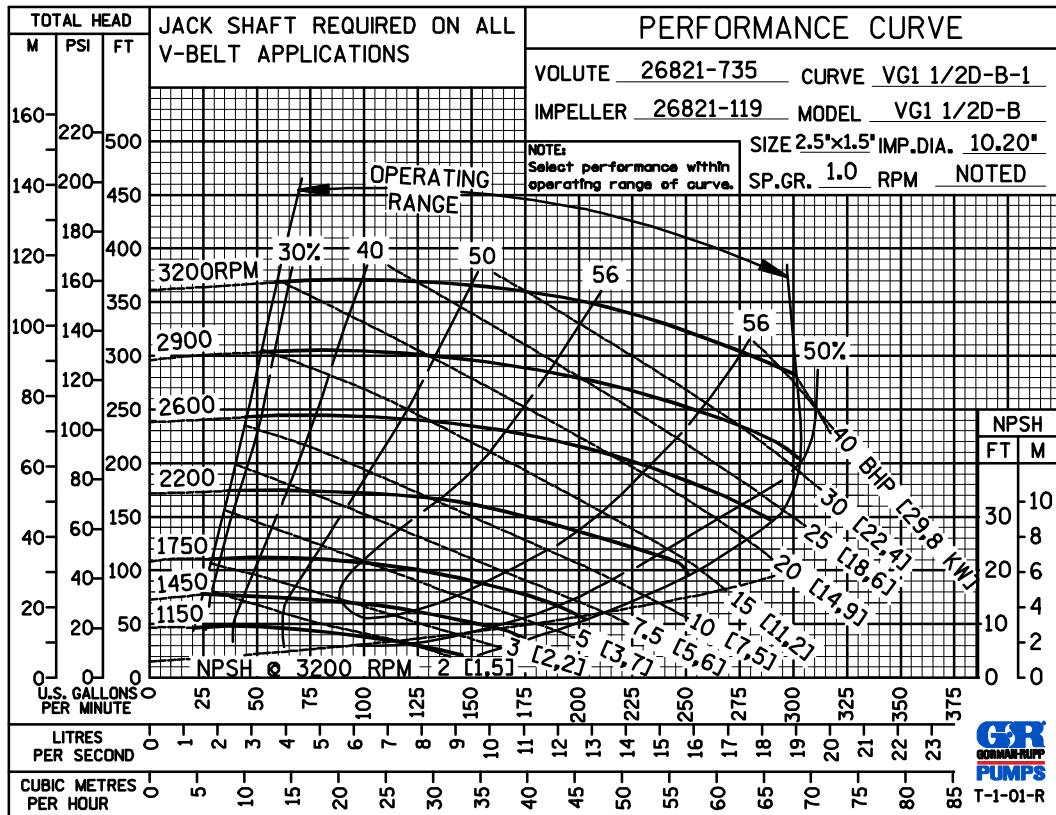
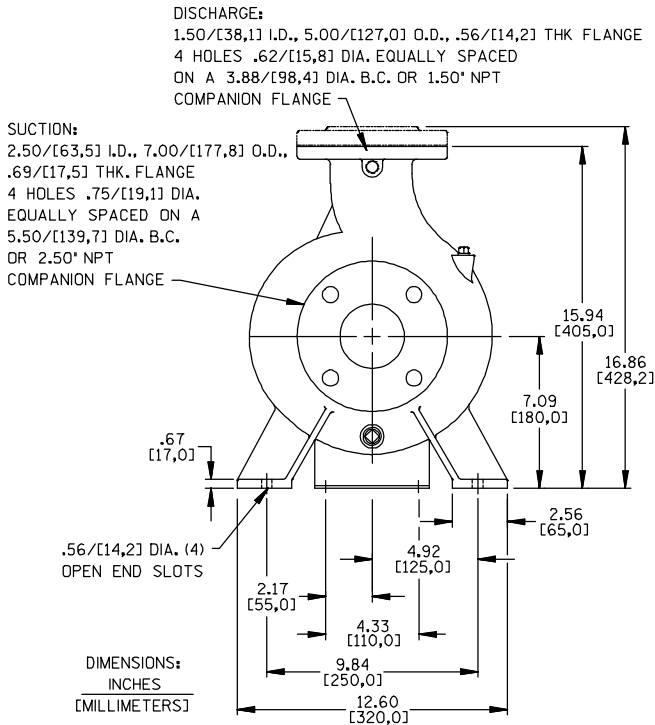

PERFORMANCE  
BASED ON  
WATER



GORMAN-RUPP PUMPS

www.grpumps.com

Specifications Subject to Change Without Notice

Printed in U.S.A.

PERFORMANCE  
BASED ON  
WATER

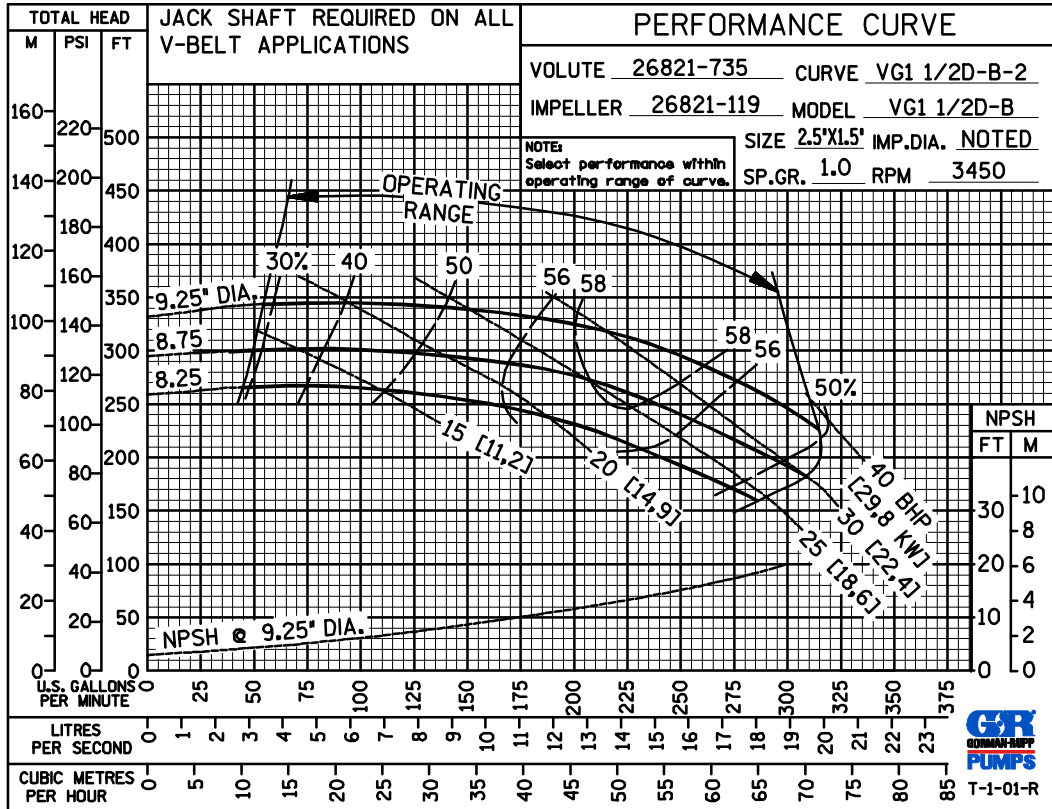

PERFORMANCE  
BASED ON  
WATER

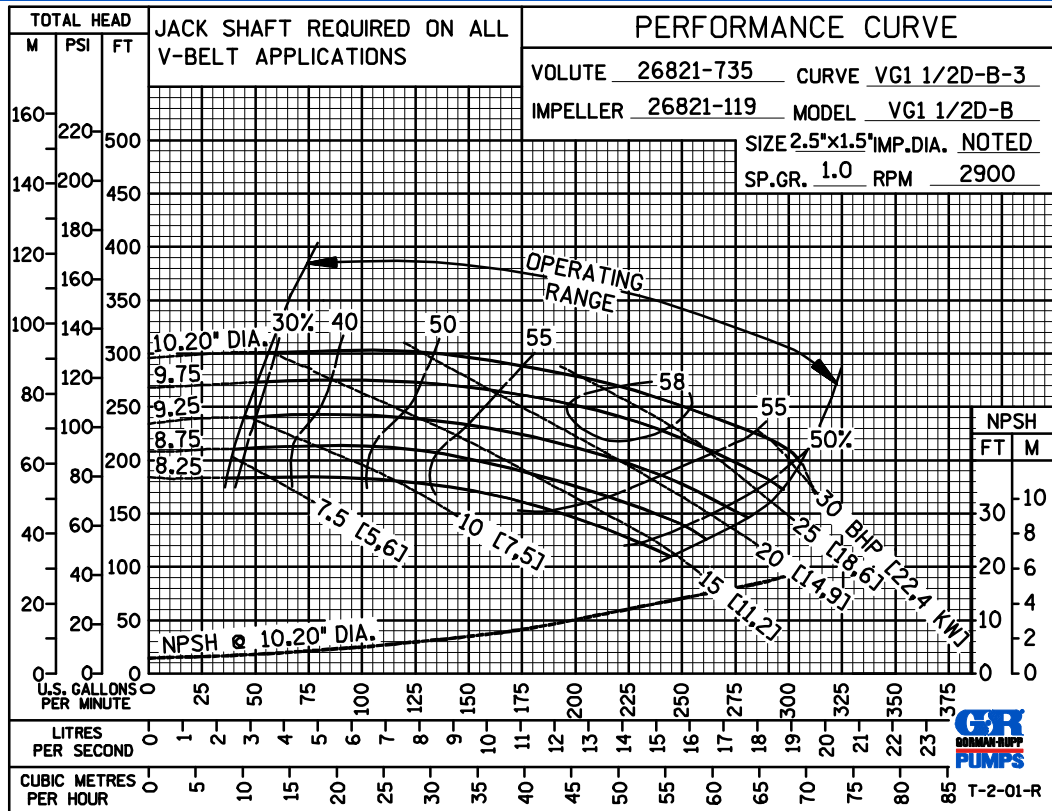

GORMAN-RUPP PUMPS

www.grpumps.com

Specifications Subject to Change Without Notice

Printed in U.S.A.

PERFORMANCE  
BASED ON  
WATER

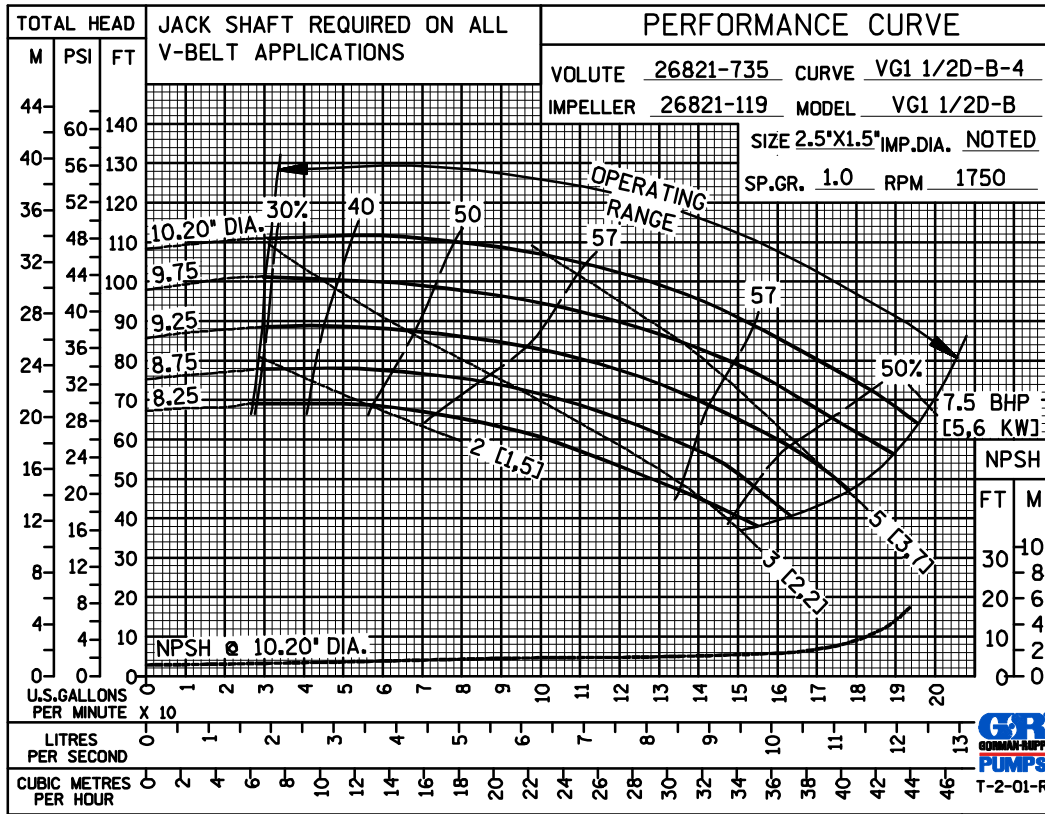

PERFORMANCE  
BASED ON  
WATER

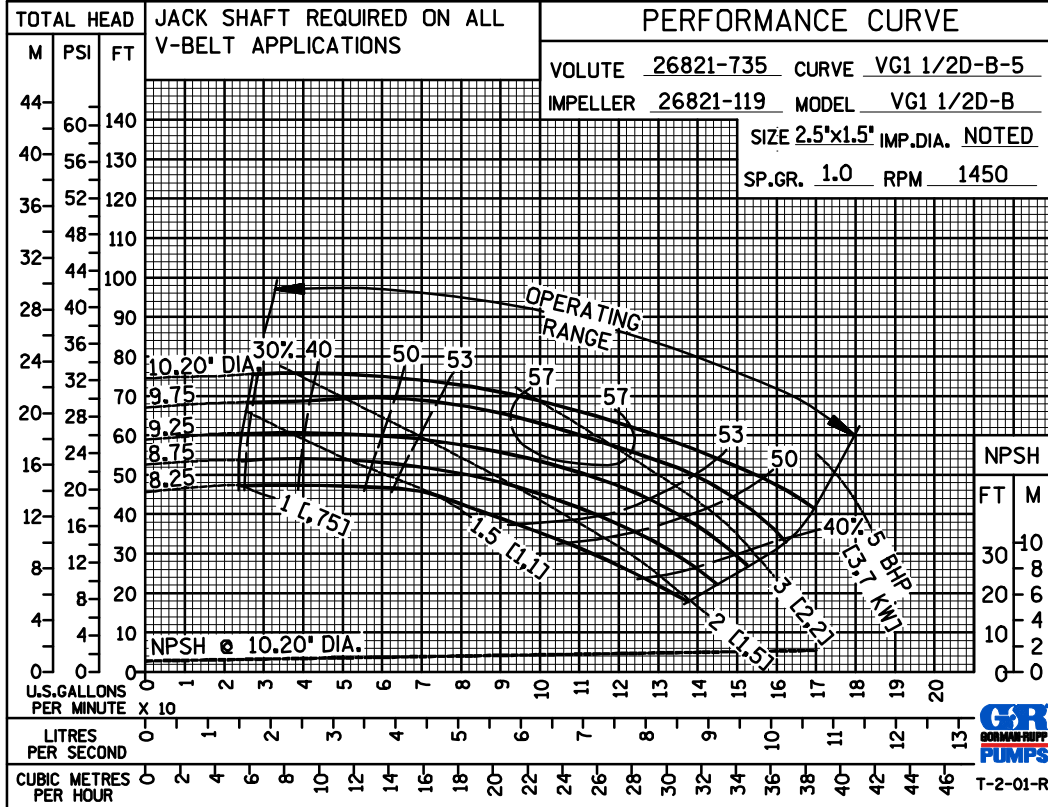

GORMAN-RUPP PUMPS

www.grpumps.com

Specifications Subject to Change Without Notice

Printed in U.S.A.

PERFORMANCE  
BASED ON  
WATER

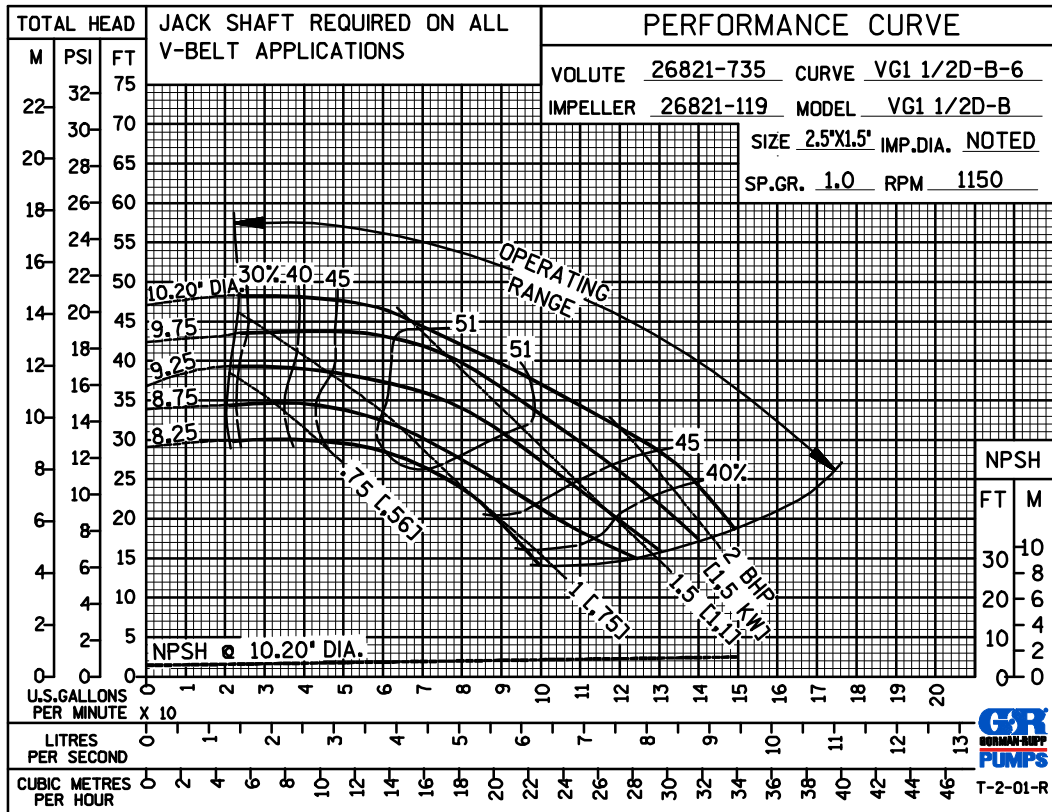

GORMAN-RUPP PUMPS

www.grpumps.com

Specifications Subject to Change Without Notice

Printed in U.S.A.