



Basic Pedestal Standard Centrifugal Pump Model VGH5C31-B

Size 6" x 5"

PUMP SPECIFICATIONS

Size: 6" x 5" (152 mm x 127 mm) Raised Face Flanges.

Casing: Ductile Iron.

Maximum Operating Pressure 182 psi (1255 kPa).*

Enclosed Type, Six Vane Impeller: Gray Iron 40.

Handles 25/32" (20 mm) Diameter Spherical Solids.

Impeller Shaft: Steel 1045.

Two Replaceable Wear Rings: Gray Iron 25.

Seal Plate: Ductile Iron.

Bypass Flush Piping.

Bearing Housing: Gray Iron 25.

Radial Bearing: Open Cylindrical Roller.

Thrust Bearing: Open Double Row Ball.

Bearing Lubrication: SAE 30 Non-Detergent Oil.

Gaskets: Nitrile Rubber.

Hardware: Standard Plated Steel.

Bearing Housing Level Oiler.

Optional Equipment: Strainer. NPT Suction and Discharge Flanges. Discharge Check Valve. Consult Factory for Optional Seals.

**Consult Factory for Applications Exceeding Maximum Pressure and/or Temperature Indicated.*

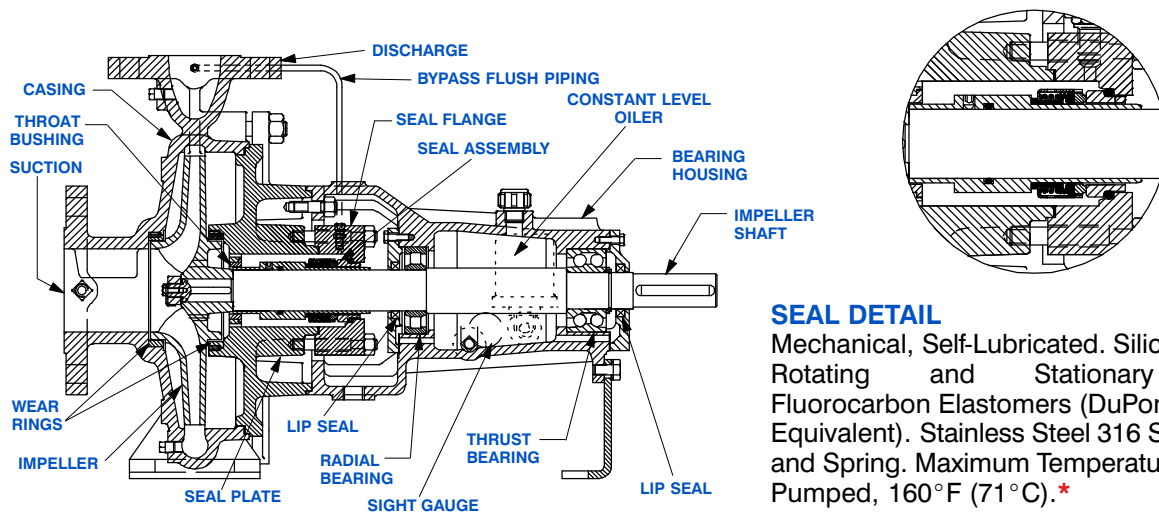

SEAL DETAIL

Mechanical, Self-Lubricated. Silicon Carbide Rotating and Stationary Faces. Fluorocarbon Elastomers (DuPont Viton® or Equivalent). Stainless Steel 316 Shaft Sleeve and Spring. Maximum Temperature of Liquid Pumped, 160°F (71°C).*



GORMAN-RUPP PUMPS

www.grpumps.com

Specifications Subject to Change Without Notice

Printed in U.S.A.

Specification Data

SECTION 70, PAGE 1026

APPROXIMATE DIMENSIONS and WEIGHTS

NET WEIGHT: 419 LBS. (190 KG.)
SHIPPING WEIGHT: 490 LBS. (222 KG.)
EXPORT CRATE SIZE: 17 CU. FT. (0,5 CU. M.)

DISCHARGE:
 .88/[22,4] DIA. 8 HOLES EQUALLY SPACED ON A
 8.50/[216,0] DIA. B.C. OR OPTIONAL 5.00-8 NPT
 COMPANION FLANGE

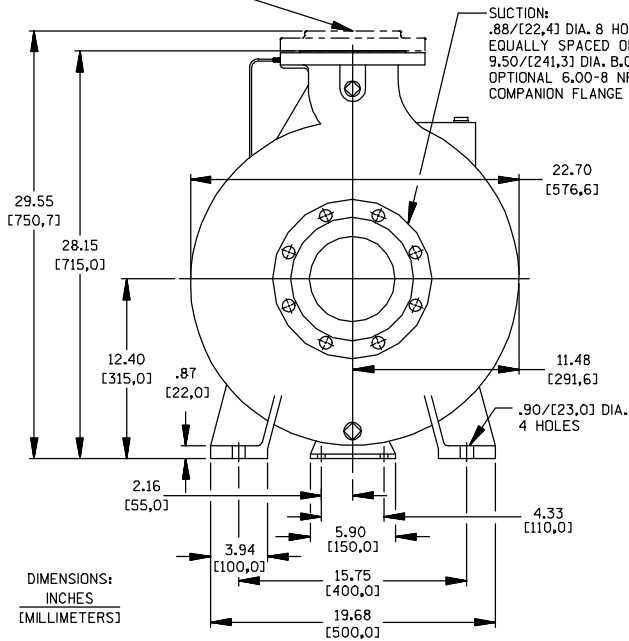

DIMENSIONS:
 INCHES
 [MILLIMETERS]

SUCTION:
 .88/[22,4] DIA. 8 HOLES EQUALLY SPACED ON A
 9.50/[241,3] DIA. B.C. OR
 OPTIONAL 6.00-8 NPT
 COMPANION FLANGE

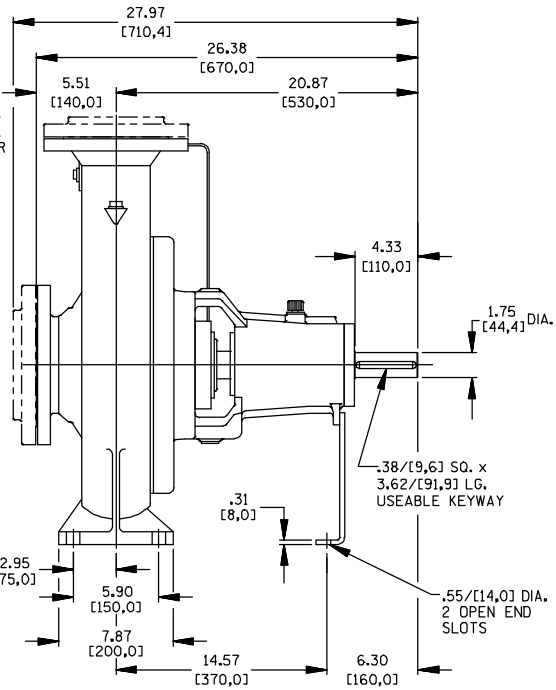

PERFORMANCE
 BASED ON
 WATER

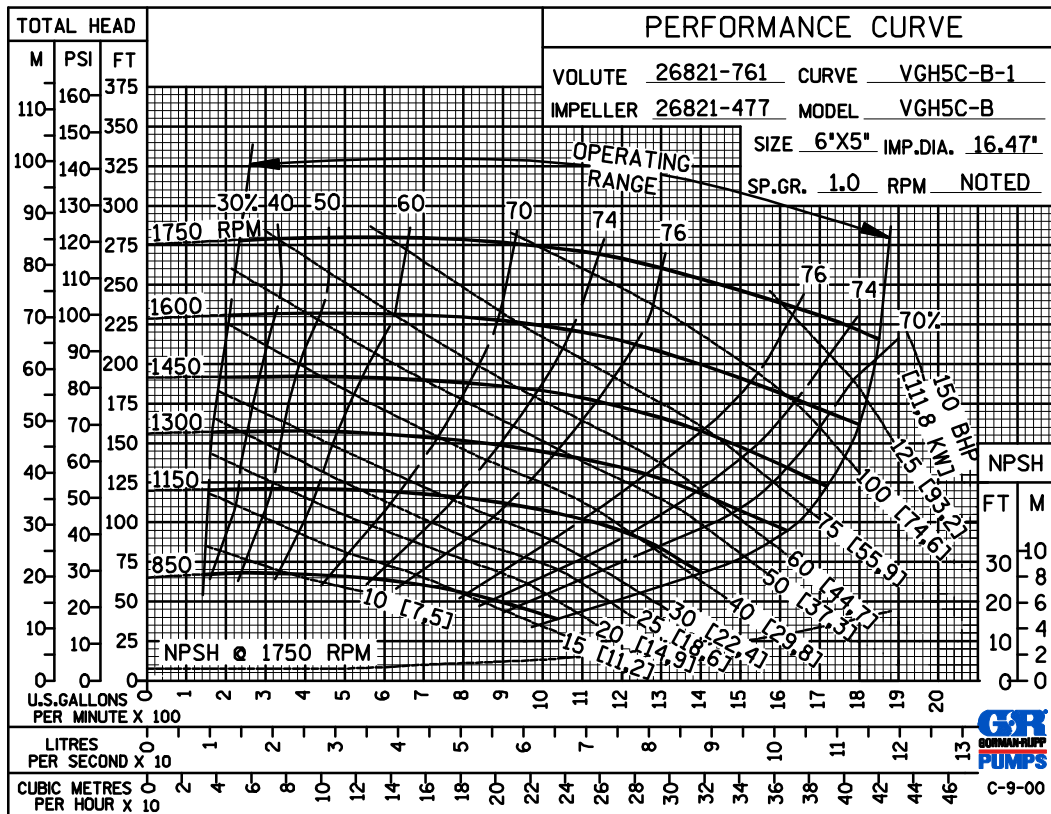

GORMAN-RUPP PUMPS

www.grpumps.com

Specifications Subject to Change Without Notice

Printed in U.S.A.

PERFORMANCE
BASED ON
WATER

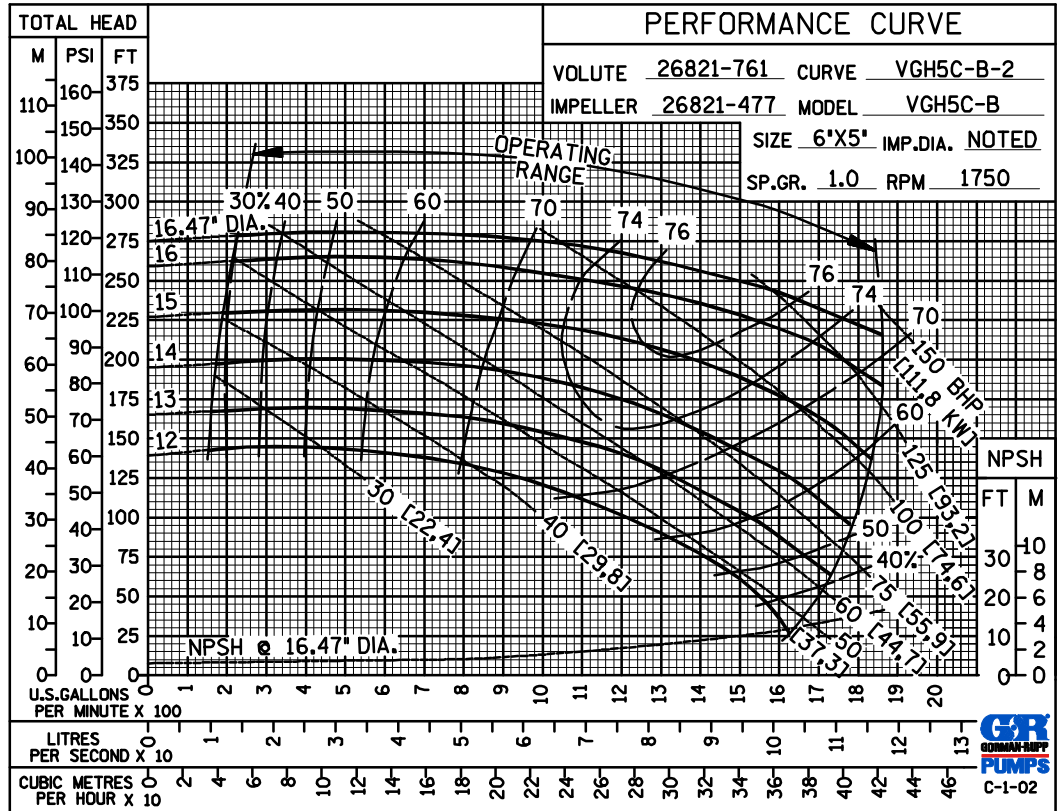

PERFORMANCE
BASED ON
WATER

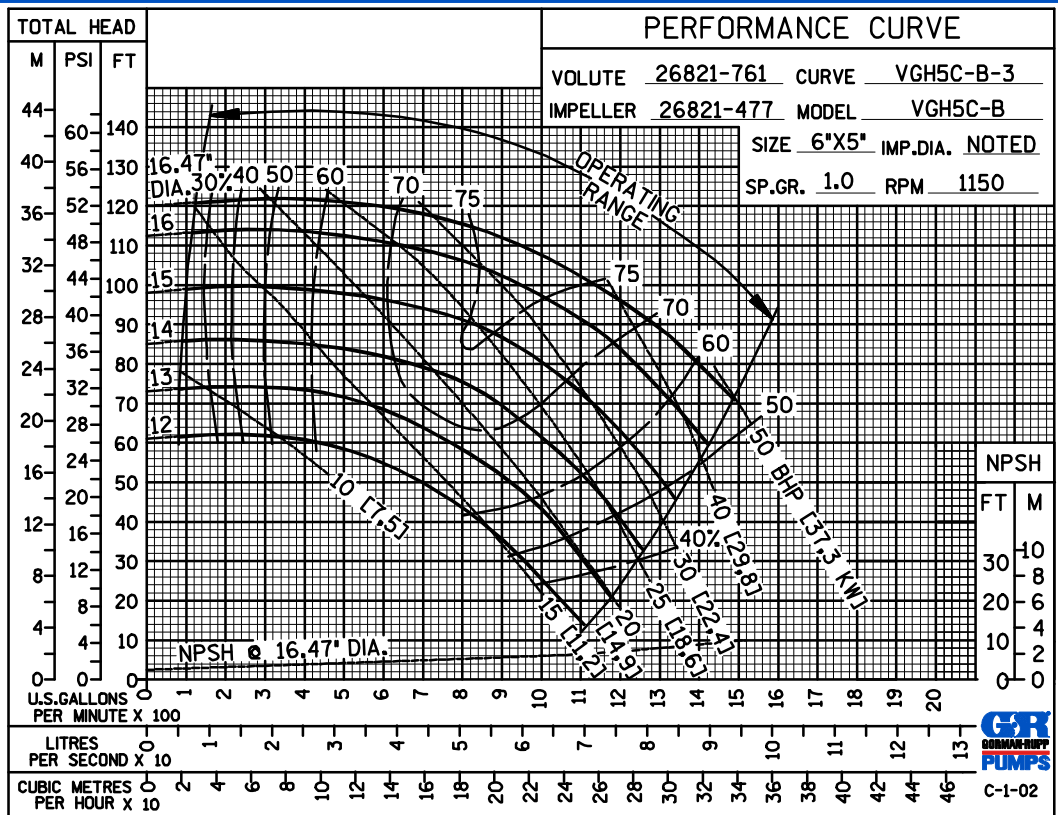

GORMAN-RUPP PUMPS

www.grpumps.com

Specifications Subject to Change Without Notice

Printed in U.S.A.

PERFORMANCE
BASED ON
WATER

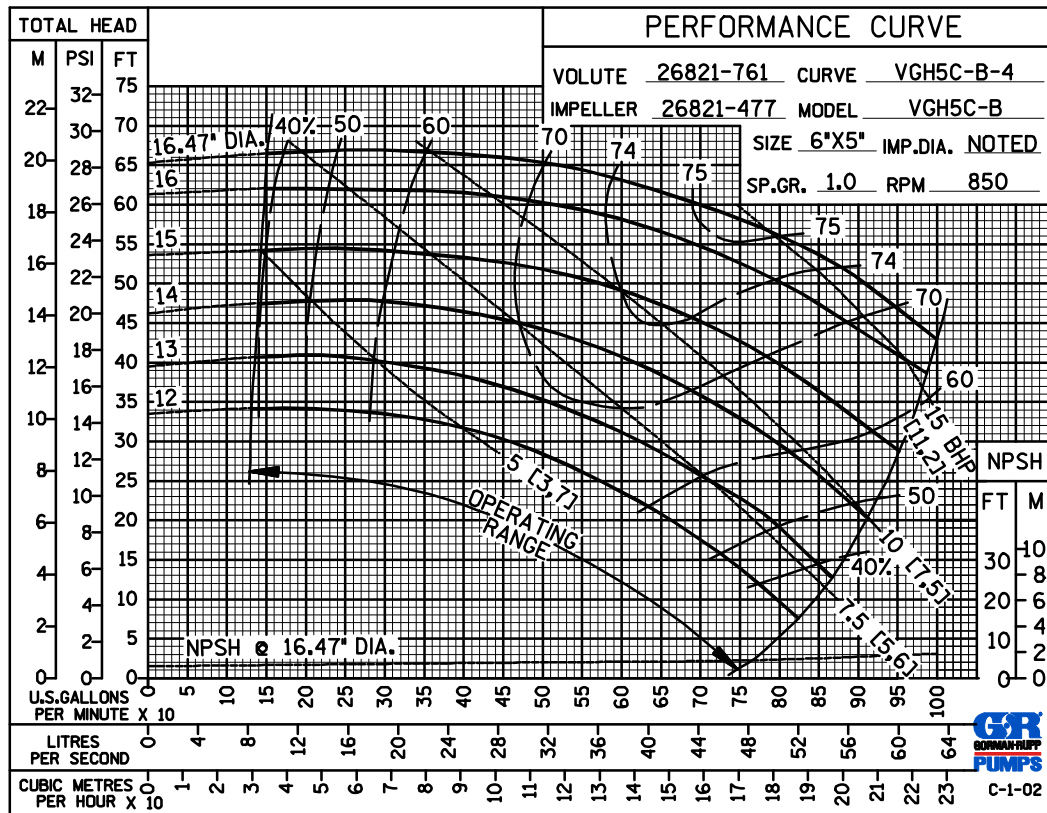

50 HERTZ
PERFORMANCE
BASED ON
WATER

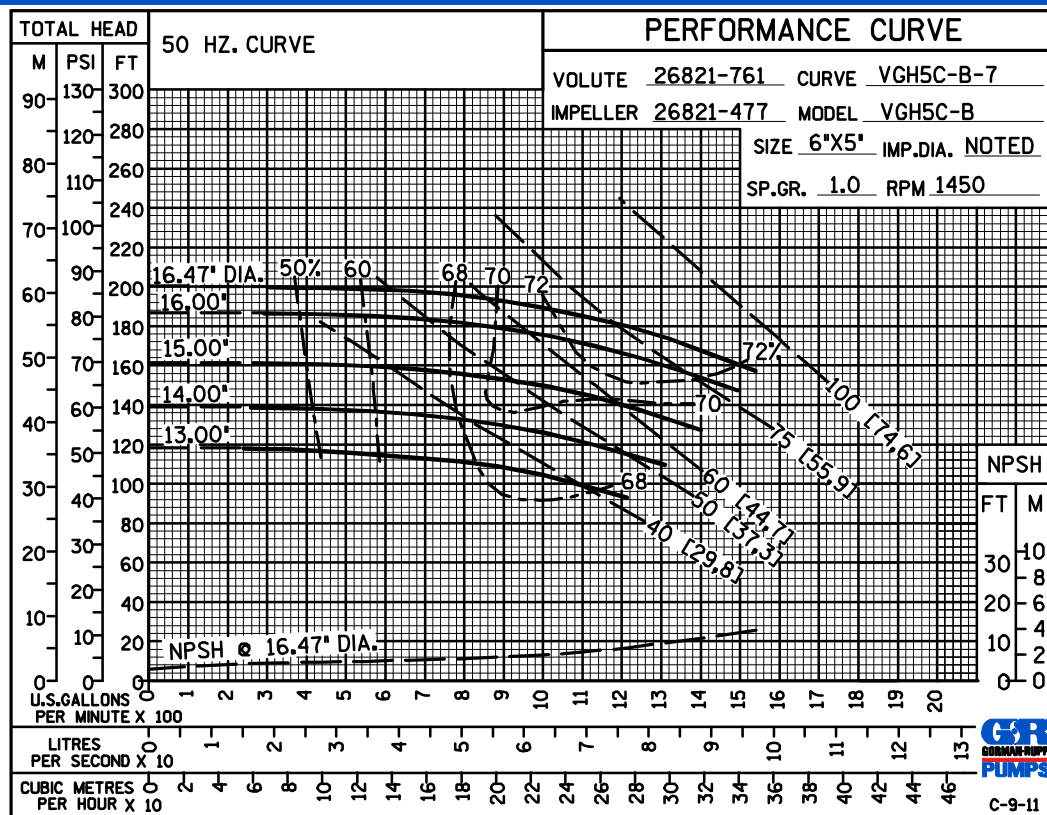

GORMAN-RUPP PUMPS

www.grpumps.com

Specifications Subject to Change Without Notice

Printed in U.S.A.

PERFORMANCE
BASED ON
PETROLEUM

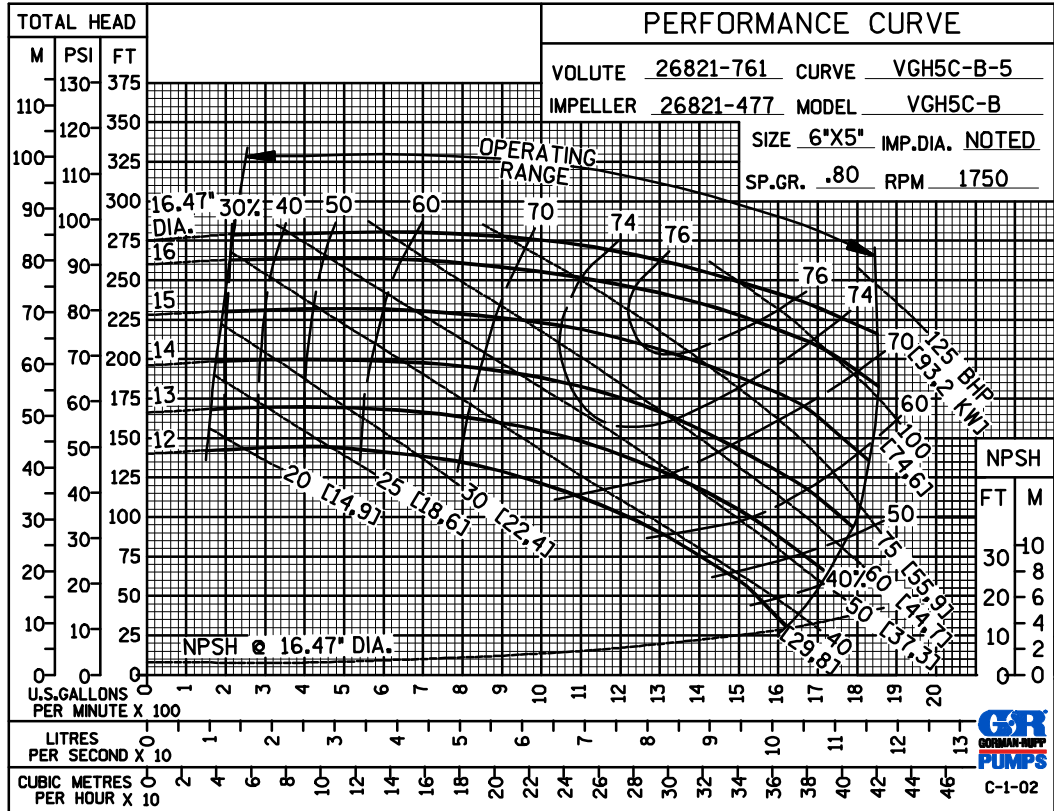

PERFORMANCE
BASED ON
PETROLEUM

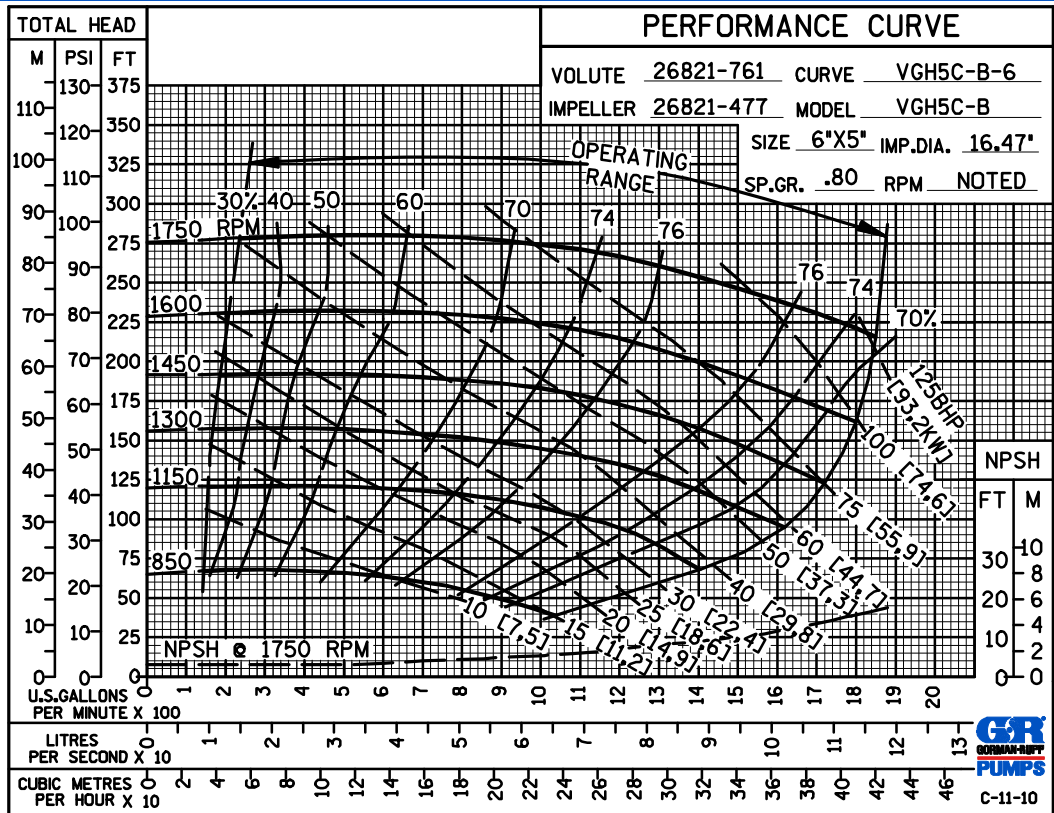

GORMAN-RUPP PUMPS

www.grpumps.com

Specifications Subject to Change Without Notice

Printed in U.S.A.

50 HERTZ
PERFORMANCE
BASED ON
PETROLEUM

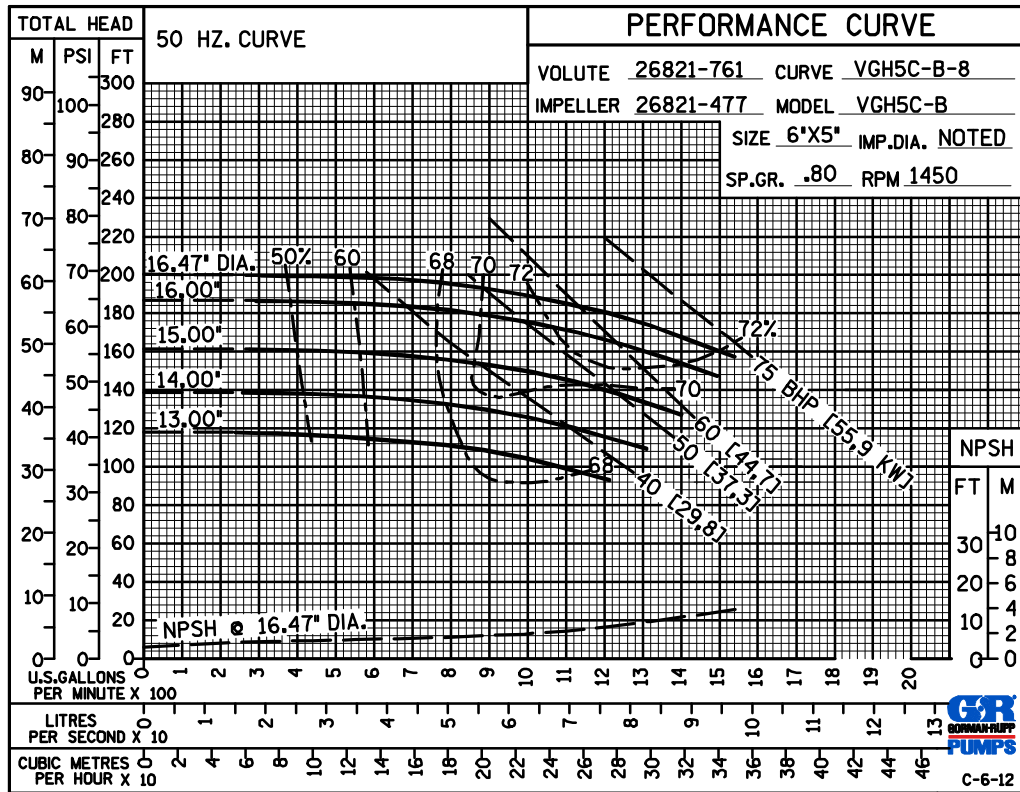

GORMAN-RUPP PUMPS

www.grpumps.com

Specifications Subject to Change Without Notice

Printed in U.S.A.