

C

Self Priming Centrifugal Pump

Model T8A60S-B

Size 8" x 8"**Super
T SERIES**

VARIOUS PATENTS APPLY

**PUMP SPECIFICATIONS****Size:** 8" (203 mm) ASA Flanged Suction x 8" (203 mm) NPT Female Discharge.**Casing:** Gray Iron 30.

Maximum Operating Pressure 83 psi (572 kPa).*

Semi-Open Type, Two Vane Impeller: Ductile Iron 65-45-12.

Handles 3" (76.2 mm) Diameter Spherical Solids.

Impeller Shaft: Alloy Steel 4150.**Shaft Sleeve:** Alloy Steel 4130.**Replaceable Wear Plate:** Gray Iron 30.**Removable Adjustable Cover Plate:** Gray Iron 30;
94 lbs. (43 kg).**Flap Valve:** Neoprene w/Nylon and Steel Reinforcing.**Seal Plate:** Gray Iron 30.**Bearing Housing:** Gray Iron 30.**Radial and Thrust Bearings:** Open Double Row Ball.**Bearing and Seal Cavity Lubrication:** SAE 30 Non-Detergent Oil.**Flanges:** Gray Iron 30.**Gaskets:** Buna-N, Compressed Synthetic Fibers, PTFE, Cork,
and Rubber.**O-Rings:** Buna-N.**Hardware:** Standard Plated Steel.**Brass Pressure Relief Valve.****Bearing and Seal Cavity Oil Level Sight Gauges.****Optional Equipment:** Metal Bellows Seal. Automatic Air

Release Valve. 120V/240V Casing Heater. High Pump

Temperature Shutdown Kit. Self-Cleaning Wear Plate.

Gray Iron 30 Spool Flanges:

8" ASA Discharge (**Specify Model T8A60S-B /F**).

200 mm DIN 2527 (PN 16) Suction and Discharge

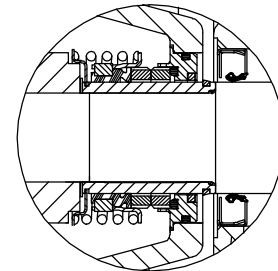
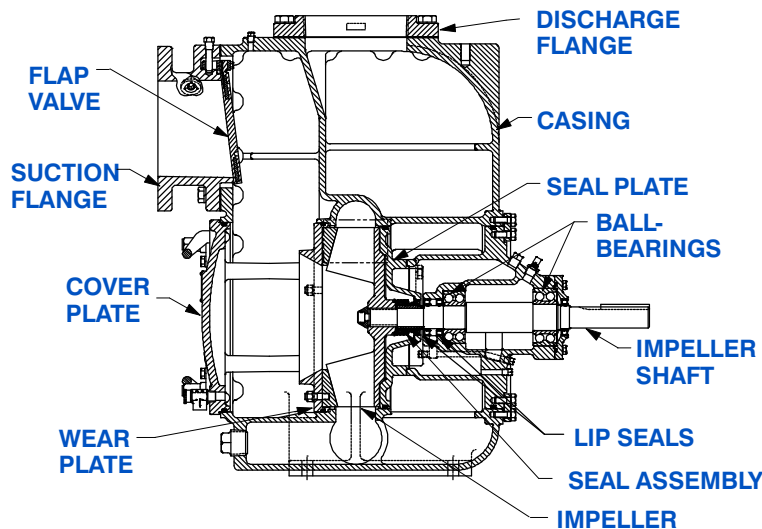
(**Specify Model T8A60S-B /FM**).**Consult Factory for Applications Exceeding
Maximum Pressure and/or Temperature Indicated.***Shown with Optional Discharge Spool
Flange (Available in ASA or DIN Standard
Sizes).****SEAL SPECIFICATIONS**

Cartridge Type, Mechanical, Oil-Lubricated, Double Floating, Self-Aligning. Silicon Carbide Rotating and Stationary Faces. Stainless Steel 316 Stationary Seat. Fluorocarbon Elastomers (DuPont Viton® or Equivalent). Stainless Steel 18-8 Cage and Spring. Maximum Temperature of Liquid Pumped, 160°F (71°C).*

**THE GORMAN-RUPP COMPANY • MANSFIELD, OHIO**

GORMAN-RUPP OF CANADA LIMITED • ST. THOMAS, ONTARIO, CANADA

www.grpumps.com

Specifications Subject to Change Without Notice

Printed in U.S.A.

Specification Data

SECTION 55, PAGE 2310

APPROXIMATE DIMENSIONS and WEIGHTS

NET WEIGHT: 1295 LBS. (587 KG.)*
SHIPPING WEIGHT: 1399 LBS. (635 KG.)*
EXPORT CRATE: 47.9 CU. FT. (1,36 CU. M.)
***ADD 35 LBS. (15,9 KG.) W/EACH SPOOL FLANGE**

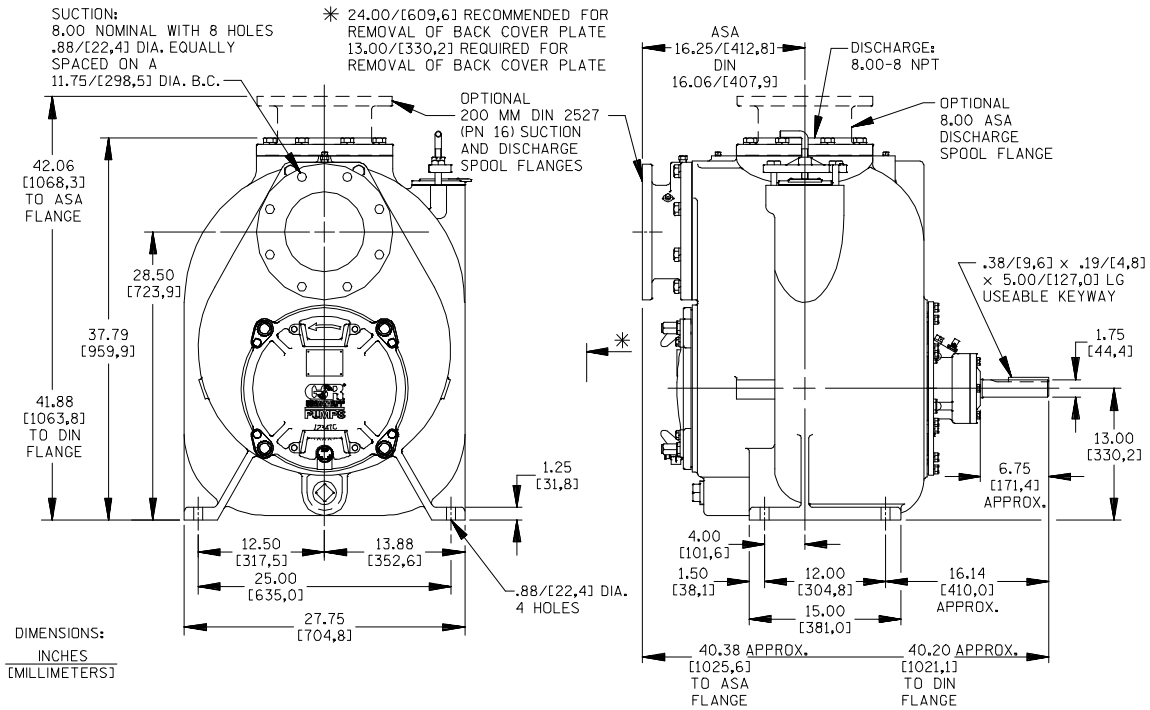

OPTIONAL ASA OR DIN STANDARD SPOOL FLANGES AVAILABLE

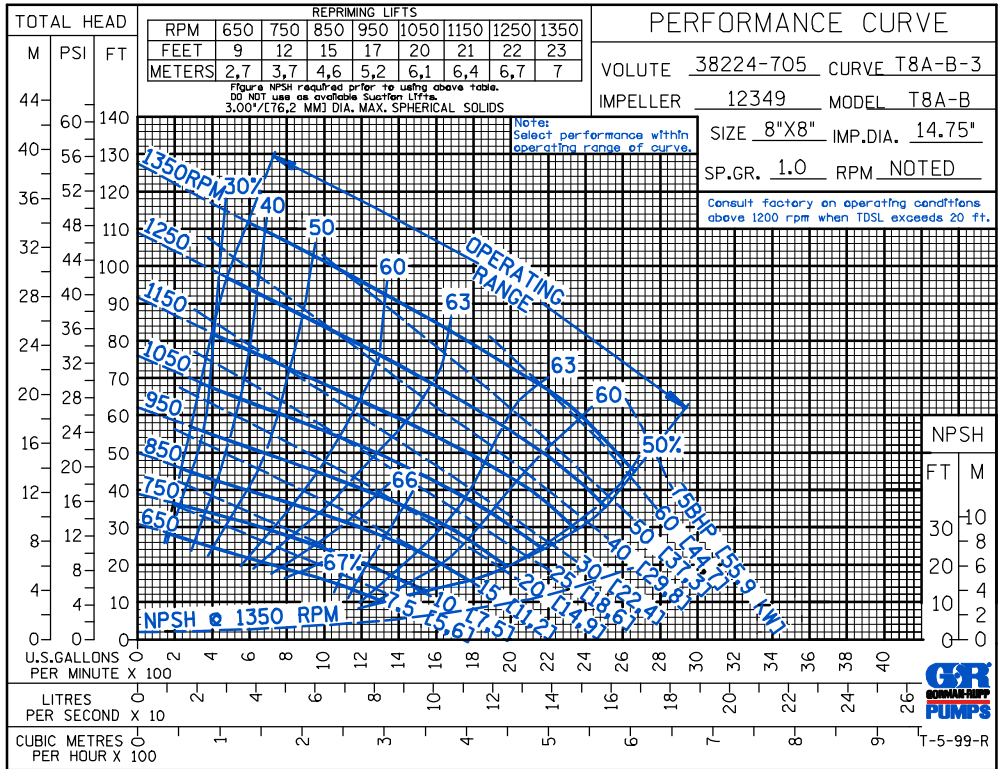

THE GORMAN-RUPP COMPANY • MANSFIELD, OHIO

GORMAN-RUPP OF CANADA LIMITED • ST. THOMAS, ONTARIO, CANADA

Specifications Subject to Change Without Notice

Printed in U.S.A.

CDS

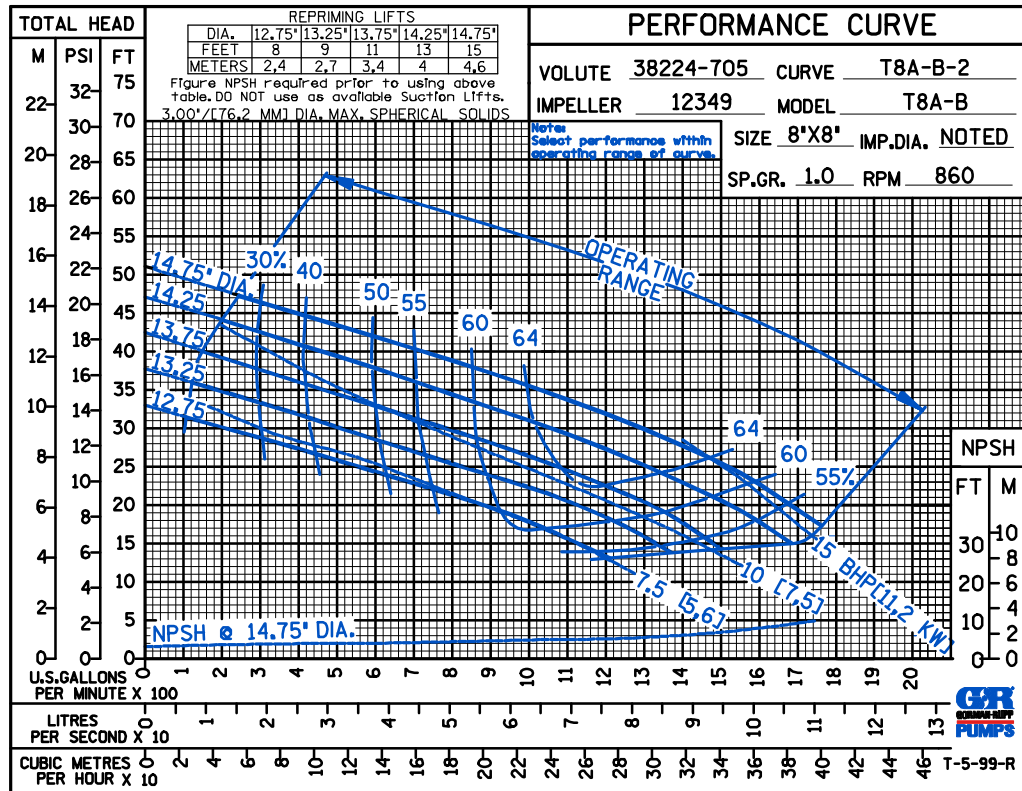
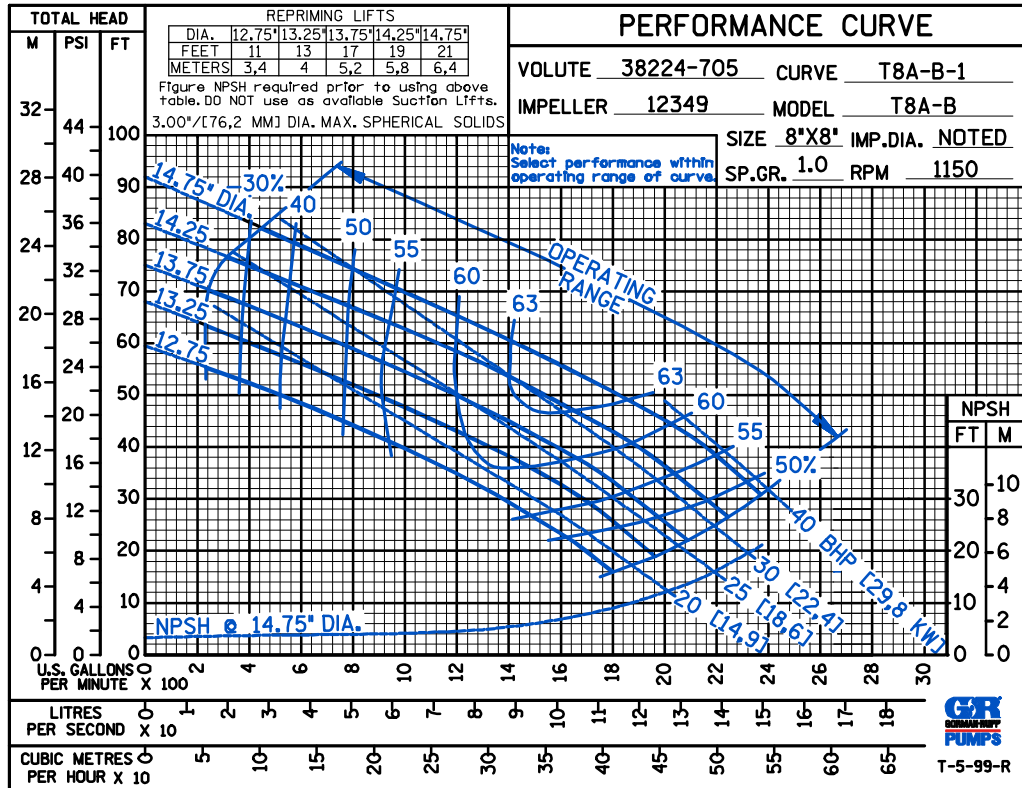

THE GORMAN-RUPP COMPANY • MANSFIELD, OHIO

GORMAN-RUPP OF CANADA LIMITED • ST. THOMAS, ONTARIO, CANADA

Specifications Subject to Change Without Notice

Printed in U.S.A.

CDS

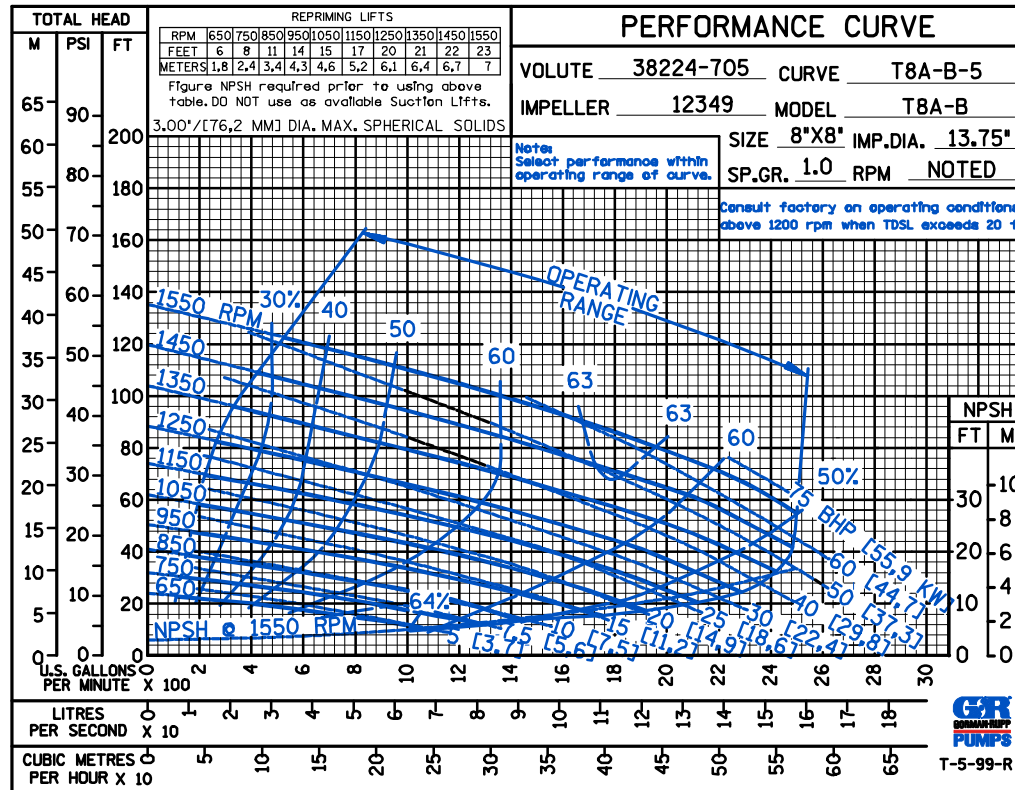
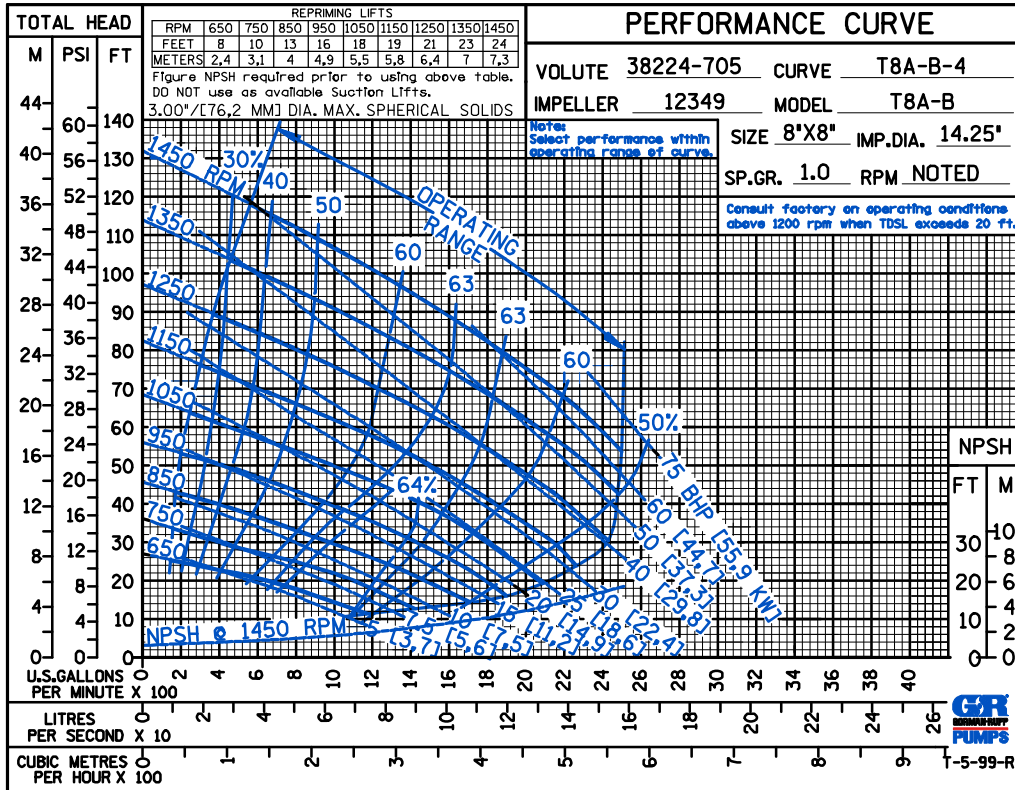

THE GORMAN-RUPP COMPANY • MANSFIELD, OHIO

GORMAN-RUPP OF CANADA LIMITED • ST. THOMAS, ONTARIO, CANADA

Specifications Subject to Change Without Notice

Printed in U.S.A.

CDS

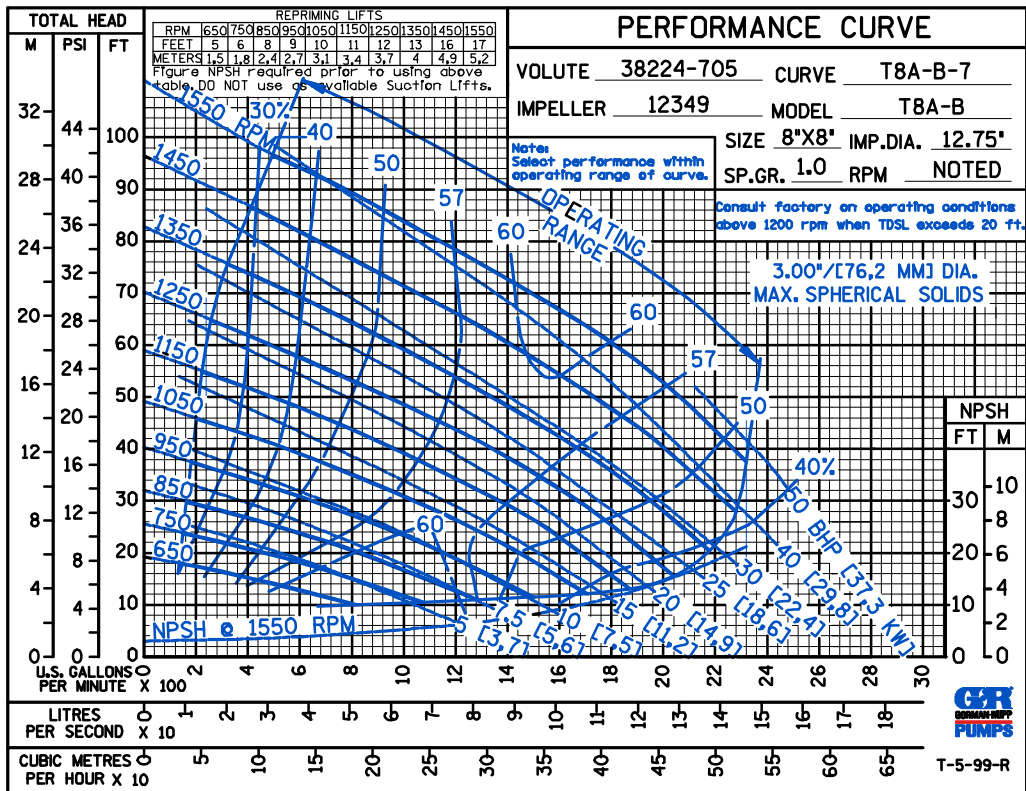
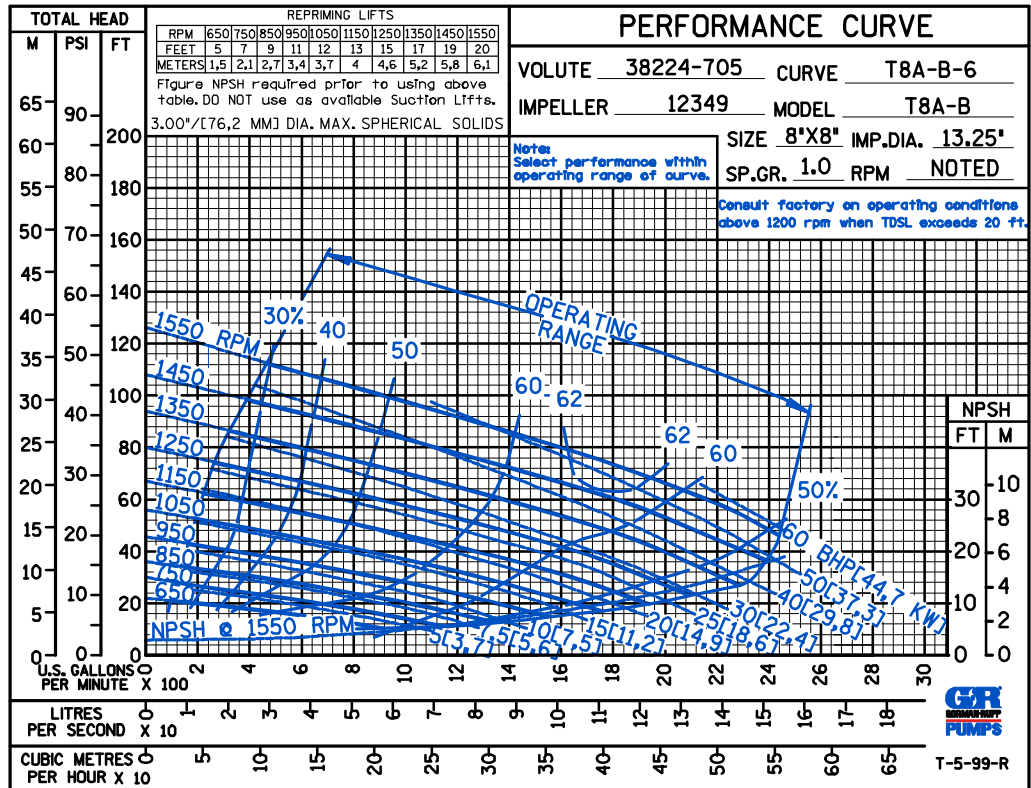

THE GORMAN-RUPP COMPANY • MANSFIELD, OHIO

GORMAN-RUPP OF CANADA LIMITED • ST. THOMAS, ONTARIO, CANADA

Specifications Subject to Change Without Notice

Printed in U.S.A.

CDS

50 HERTZ

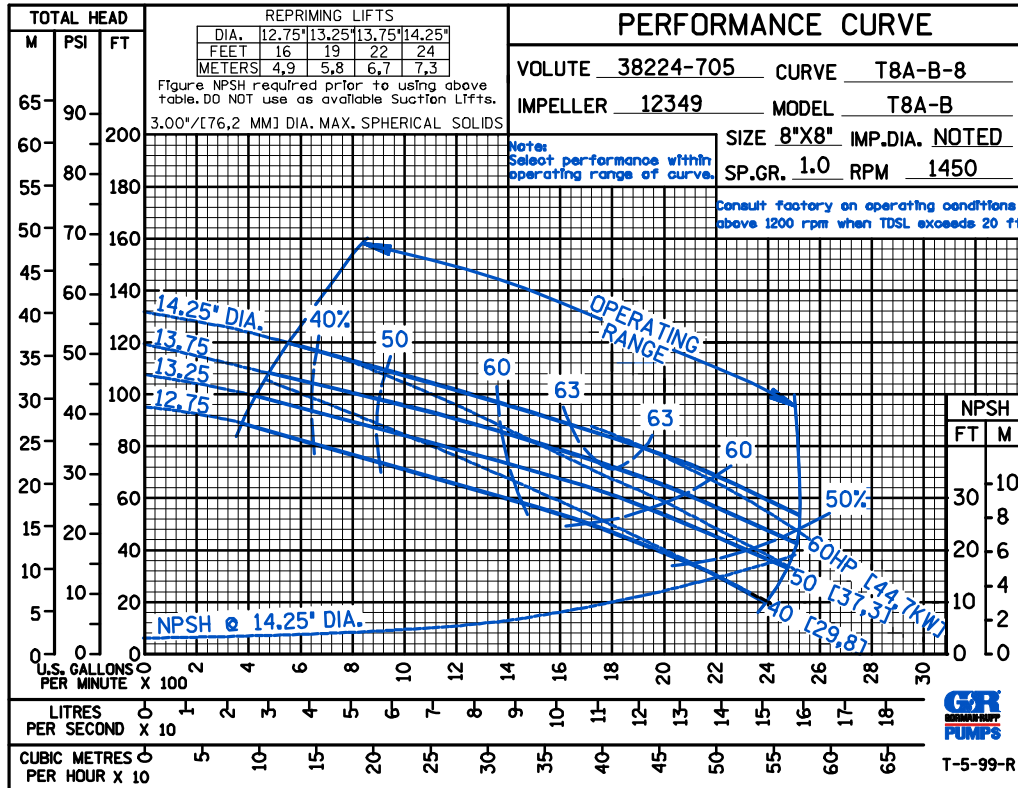

T-5-99-R

50 HERTZ

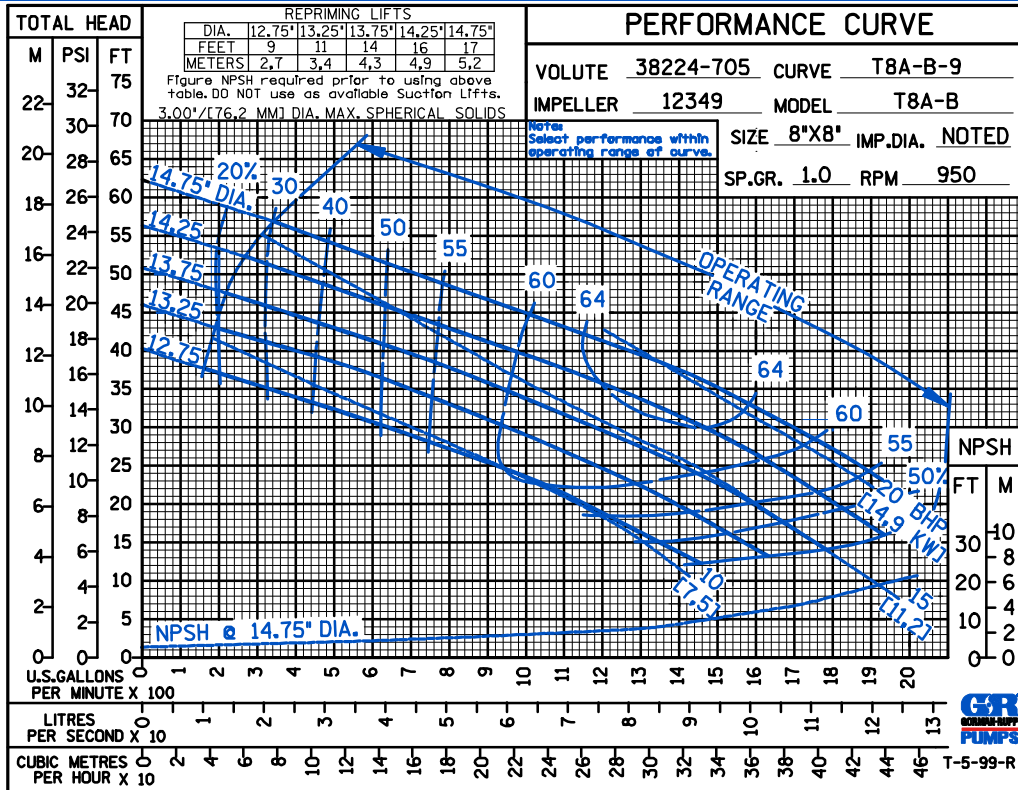

T-5-99-R



THE GORMAN-RUPP COMPANY • MANSFIELD, OHIO

GORMAN-RUPP OF CANADA LIMITED • ST. THOMAS, ONTARIO, CANADA

Specifications Subject to Change Without Notice

Printed in U.S.A.

CDS

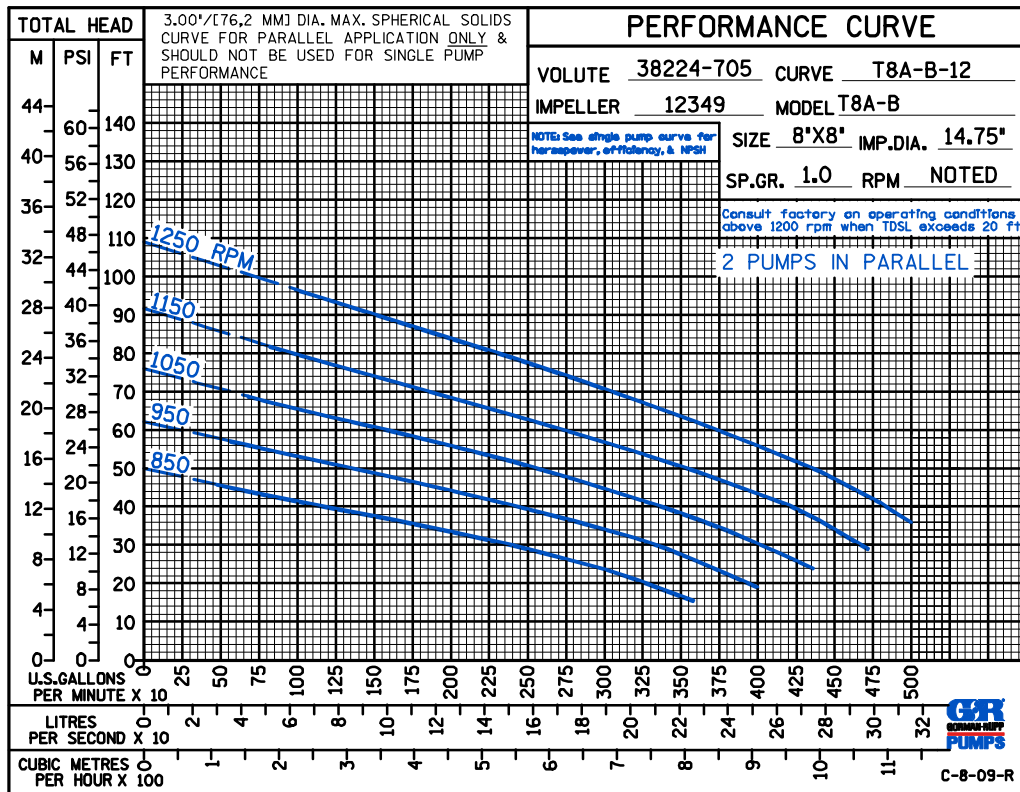
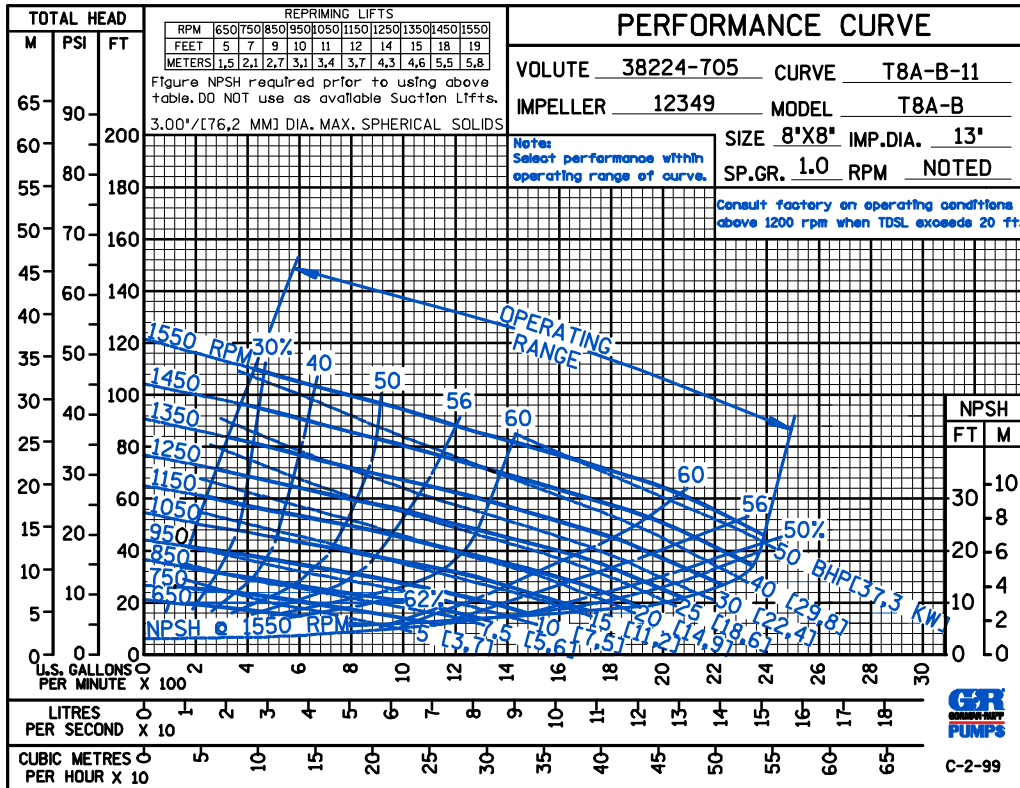

THE GORMAN-RUPP COMPANY • MANSFIELD, OHIO

GORMAN-RUPP OF CANADA LIMITED • ST. THOMAS, ONTARIO, CANADA

Specifications Subject to Change Without Notice

Printed in U.S.A.

