

Standard Centrifugal Pump

Model VGH6E31-B

Size 8" x 6"



PUMP SPECIFICATIONS

Size: 8" x 6" (203 mm x 152 mm) Raised Face Flanges.

Casing: Ductile Iron.

Maximum Casing Pressure 263 psi (1813 kPa).*

Maximum Operating Pressure 250 psi (1723 kPa)
at Temperatures up to 100° F (37° C) Based
on System Component Limitations.*

Enclosed Type, Six Vane Impeller: Gray Iron 40.
Handles 1" (25,4 mm) Diameter Spherical Solids.

Impeller Shaft: Steel 1045.

Two Replaceable Wear Rings: Gray Iron 25.

Seal Plate: Ductile Iron.

Bypass Flush Piping.

Bearing Housing: Gray Iron 25.

Radial Bearing: Open Cylindrical Roller.

Thrust Bearing: Open Double Row Ball.

Bearing Lubrication: SAE 30 Non-Detergent Oil.

Gaskets: Nitrile Rubber.

Hardware: Standard Plated Steel.

Bearing Housing Level Oiler.

Optional Equipment: Strainer. NPT Suction and Discharge
Flanges. Discharge Check Valve. Stainless Steel Impeller.
Consult Factory for Optional Seals.



**Consult Factory for Applications Exceeding
Maximum Pressure and/or Temperature Indicated.*

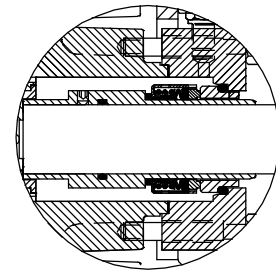
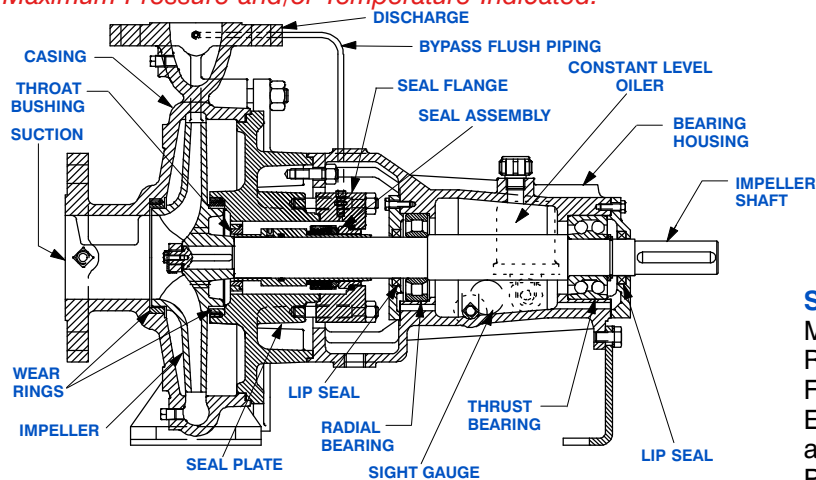

SEAL DETAIL

Mechanical, Self-Lubricated. Silicon Carbide Rotating and Stationary Faces. Fluorocarbon Elastomers (DuPont Viton® or Equivalent). Stainless Steel 316 Shaft Sleeve and Spring. Maximum Temperature of Liquid Pumped, 160° F (71° C).*



GORMAN-RUPP PUMPS

www.grpumps.com

Specifications Subject to Change Without Notice

Printed in U.S.A.

60 HERTZ
PERFORMANCE
BASED ON
WATER

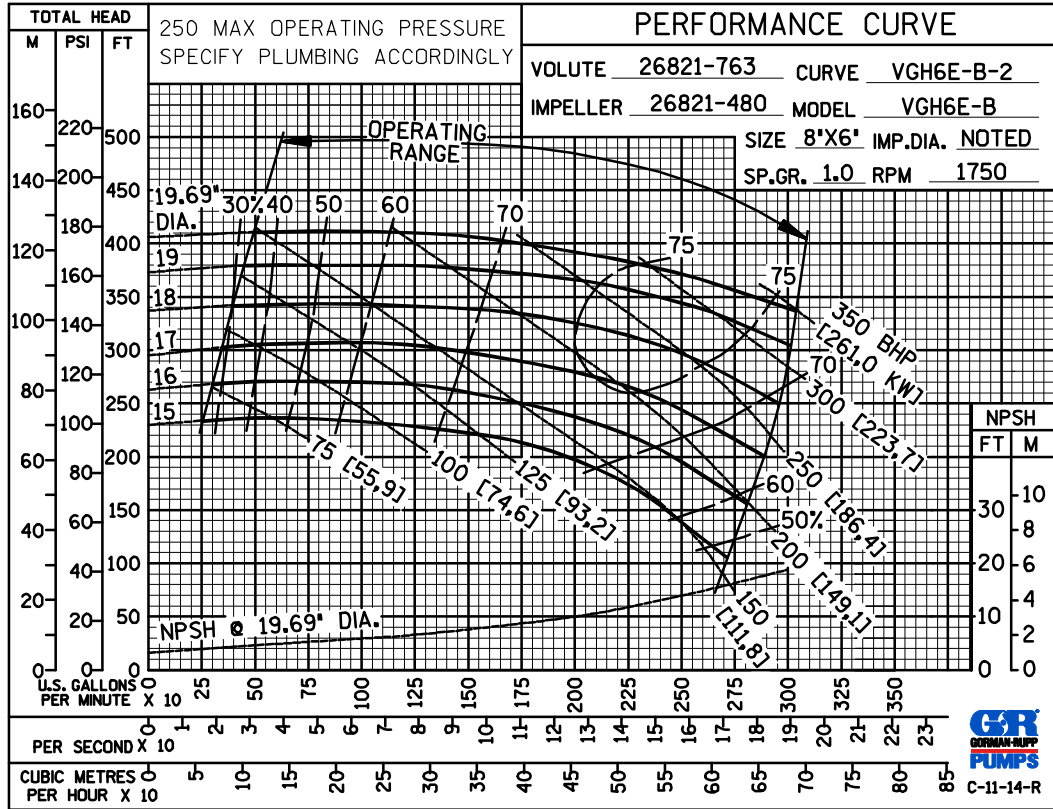

60 HERTZ
PERFORMANCE
BASED ON
WATER

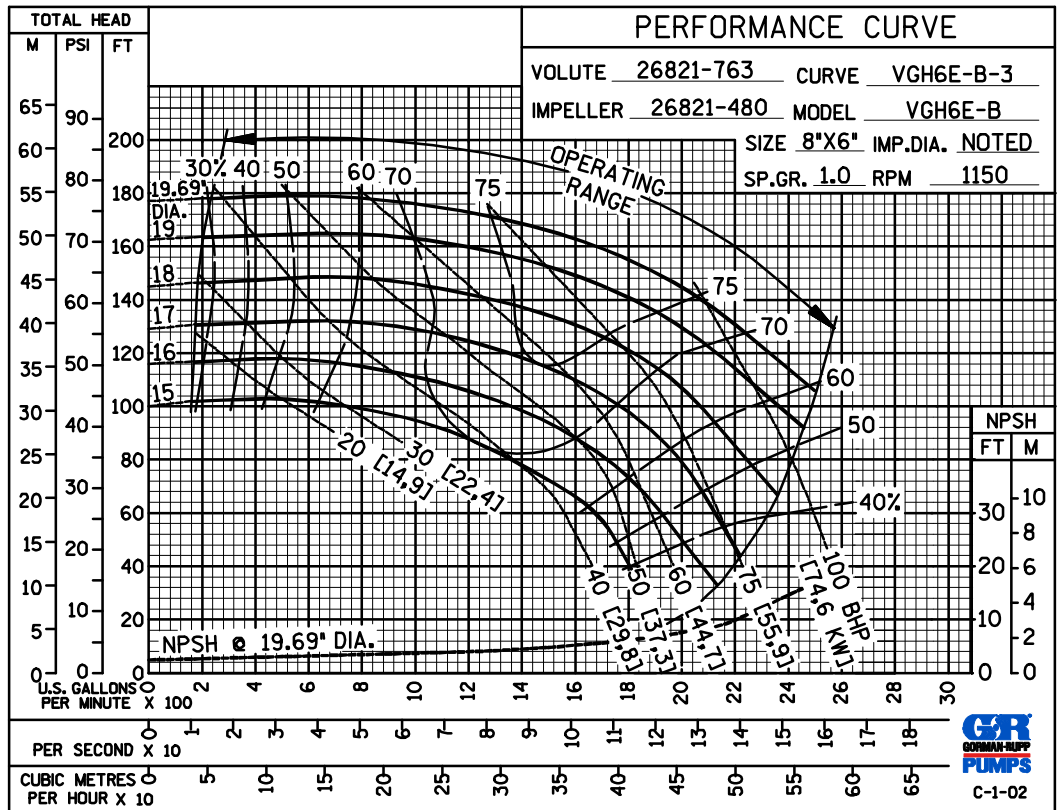

GORMAN-RUPP PUMPS

www.grpumps.com

Specifications Subject to Change Without Notice

Printed in U.S.A.

60 HERTZ
PERFORMANCE
BASED ON
WATER

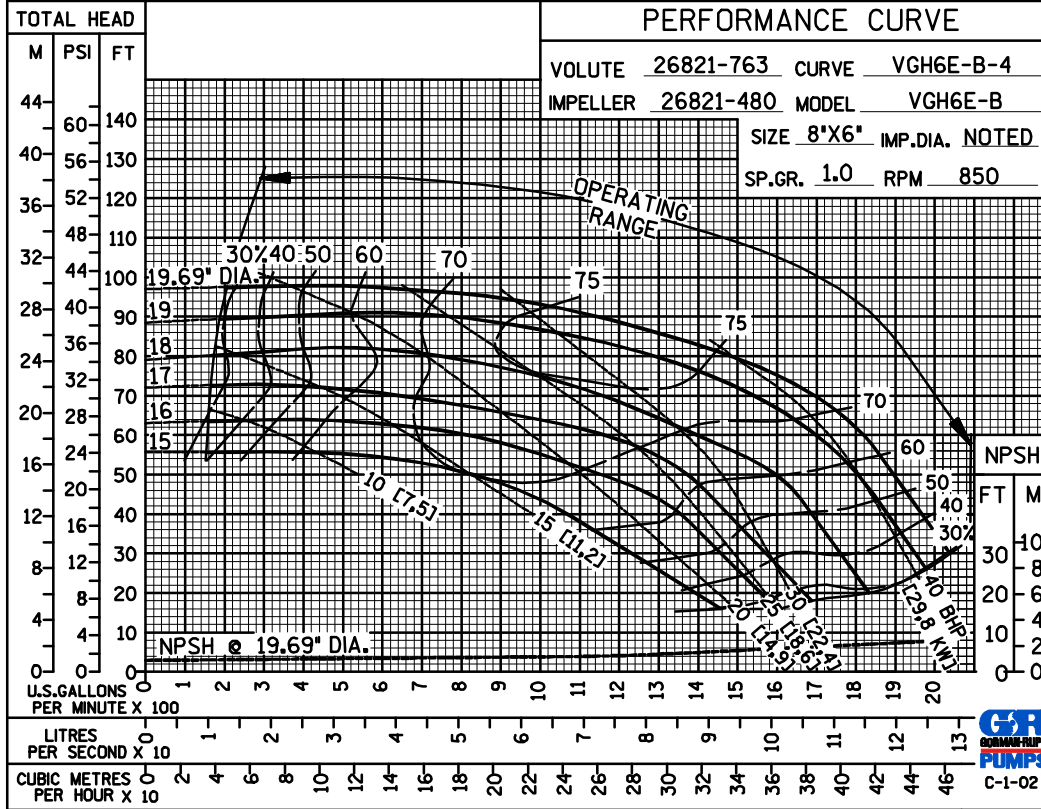

60 HERTZ
PERFORMANCE
BASED ON
PETROLEUM

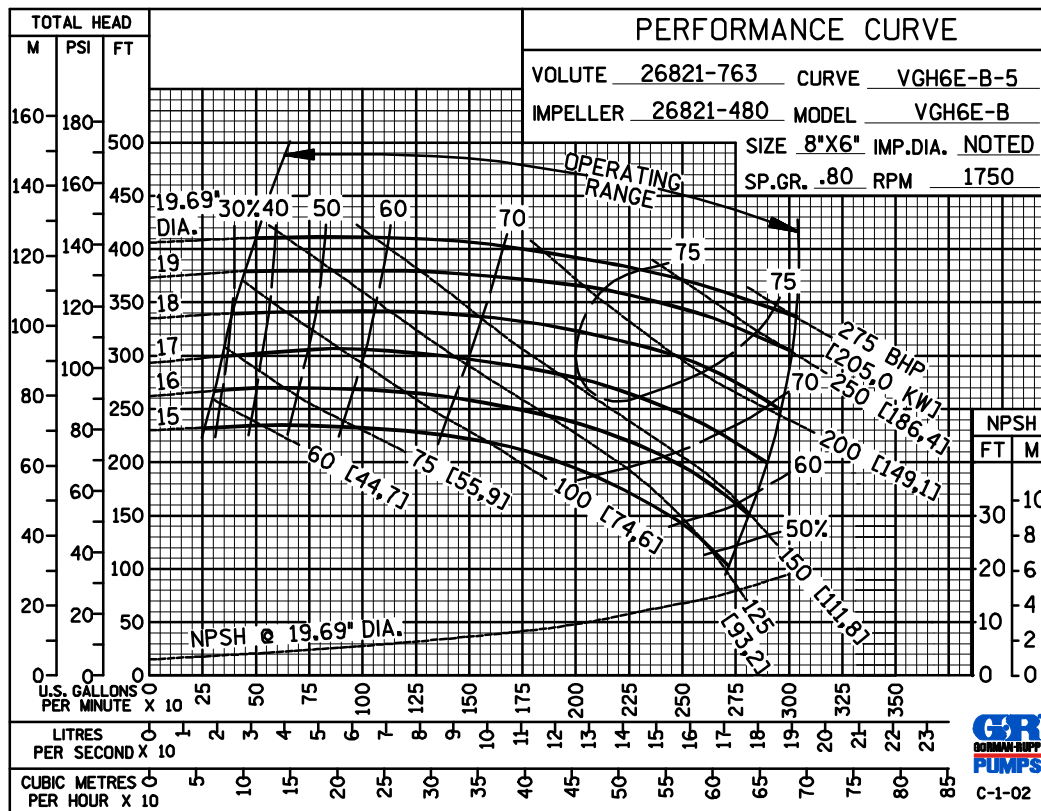

GORMAN-RUPP PUMPS

www.grpumps.com

Specifications Subject to Change Without Notice

Printed in U.S.A.

50 HERTZ
PERFORMANCE
BASED ON
WATER

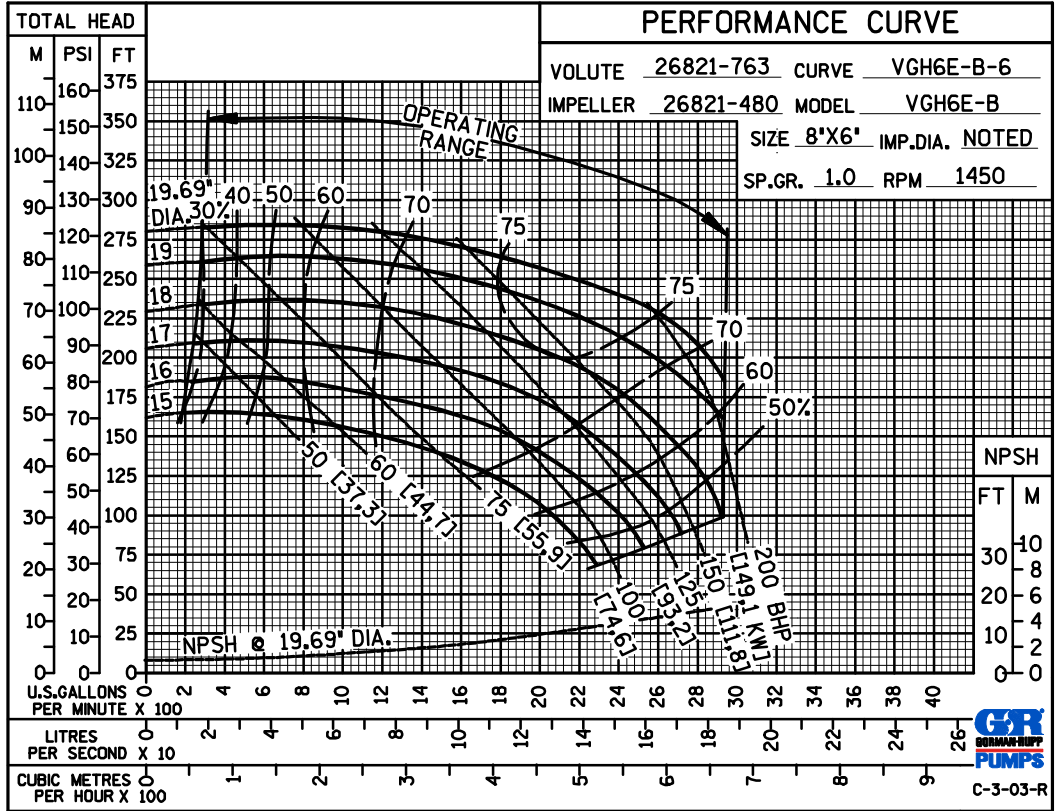

50 HERTZ
PERFORMANCE
BASED ON
PETROLEUM

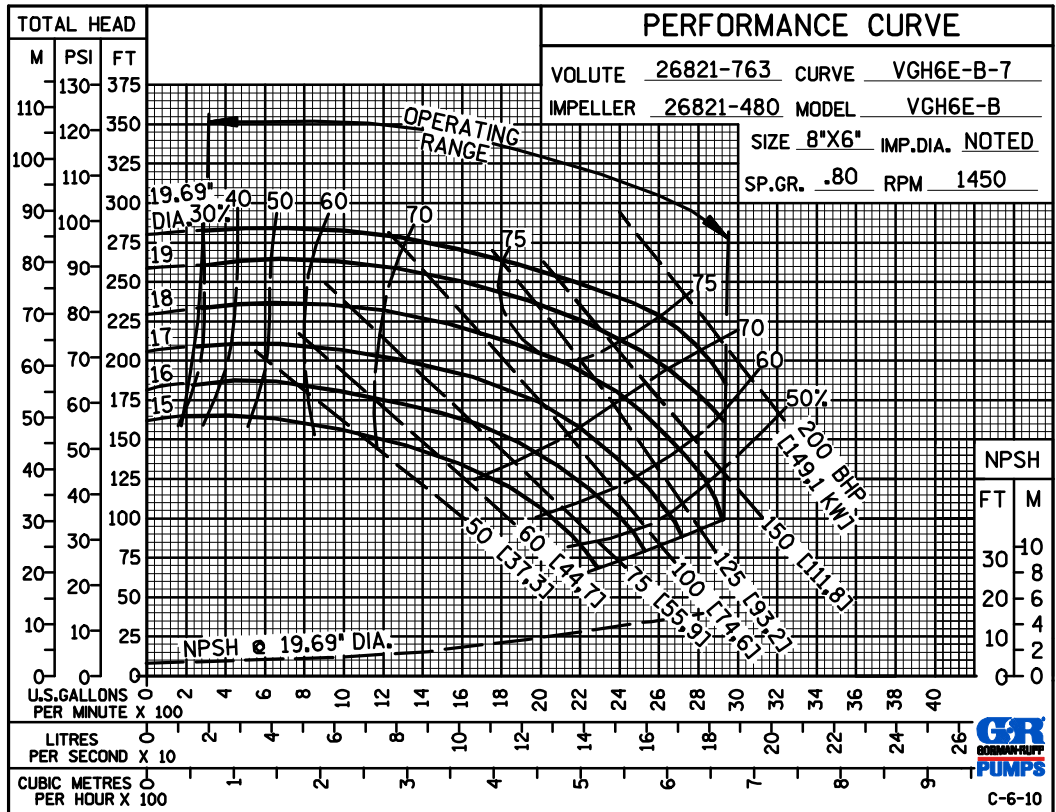

GORMAN-RUPP PUMPS

www.grpumps.com

Specifications Subject to Change Without Notice

Printed in U.S.A.