

# GHS SERIES HEAVY DUTY STANDARD; S & T HYD SIZE ROTARY GEAR PUMP

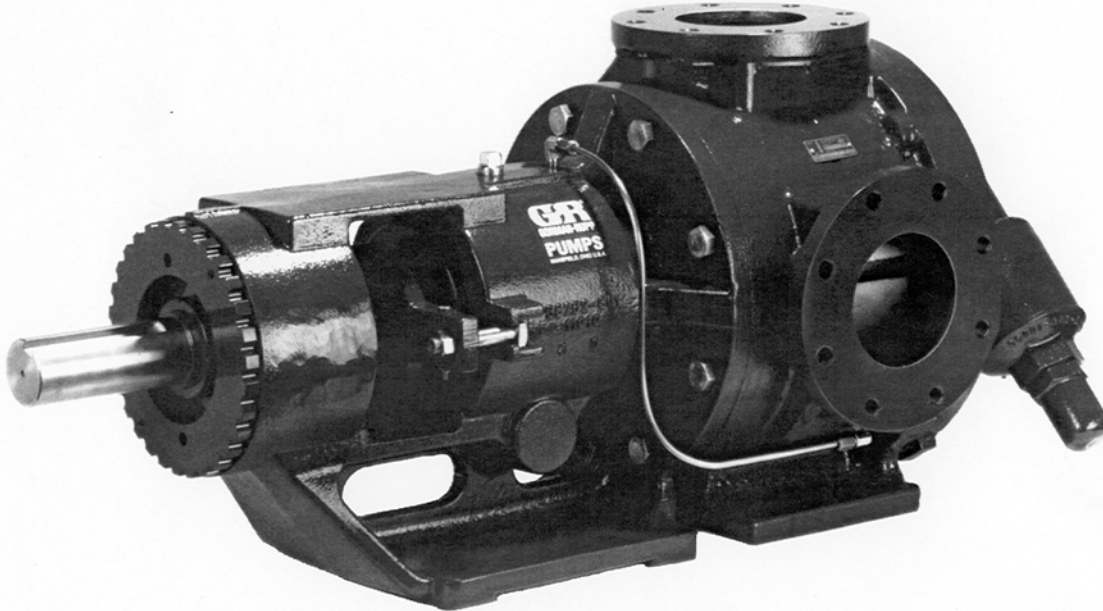

The GHS iron, high capacity series is designed for applications in the operating ranges noted below. These units are ideal for bulk handling of thin or viscous liquids. For temperature control, backhead and housing jackets are standard; head jackets are available. Also, carbon graphite bushings for low viscosity liquids, silicon carbide bushings for wear resistance, and numerous shaft seal options are described on the following pages.

This heavy duty series provides superior rotor shaft support and an integral, maintenance-free radial/thrust bearing, for reduced deflection and wear.

### FEATURES

*BALL BEARING THRUST CONTROL  
 ROTOR END CLEARANCE EXTERNALLY  
 ADJUSTABLE  
 HIGH STRENGTH, COMPUTER  
 PROFILED GEARING FOR QUIET  
 OPERATION  
 RUGGED, DURABLE CONSTRUCTION  
 JACKETED HOUSING AND BACKHEAD  
 FLEXIBLE SEAL DESIGN ALLOWS FOR  
 A VARIETY OF INDUSTRIAL  
 STANDARD SEALS OR PACKING*

### OPERATING RANGE

CAPACITY (GPM) : (40 TO 600)  
 [LPM] : [151 TO 2270]  
 PRESSURE (PSI) : [0 TO 200]  
 [BAR] : [0 TO 14]  
 VISCOSITY (SSU) : (28 TO 2,000,000)  
 [cSt] : [1 TO 440,000]  
 TEMPERATURE (F) : (-60° TO 500°)  
 [C] : [-51° TO 260°]

### APPLICATIONS

USE WITH ANY CLEAN LIQUID  
 COMPATIBLE WITH CAST  
 IRON

- ★ BOOSTER SERVICE
- ★ CIRCULATING
- ★ FILTERING
- ★ LUBRICATING
- ★ TRANSFERRING
- ★ METERING

EXTER- IOR	ROTOR & IDLER	HOUSING PORTS	BUSHINGS	IDLER PIN	SHAFT	SHAFT SEALING		ROTATION	INTERNAL RELIEF VALVE	
						MECH. SEAL ●	PACKING ■		MATERIAL	SETTING
CAST IRON	HIGH STRENGTH IRON	90° 125# FLG	① BRONZE	HARDENED STEEL	STEEL	VITON	CARBON FIBER	C.W.	CAST IRON	75 PSI [5 BAR]

## Standard Models

**G H S 4 SU 3 - B**  
 | | | | | | | | | |  
 GEAR DUTY DESIGN PORT SIZE HYDRAULIC SEAL STYLE  
 SIZE SIZE

MODEL NUMBER	NOM. CAPACITY - SPEED		MAXIMUM			TEMP.	SHIPPING DATA	
	MAXIMUM		DIFFERENTIAL PRESSURE-PSI [BAR]				Weight LBS [KG]	Volume CU. FT.
	GPM [LPM]	RPM	BELOW 38 SSU 14 cSt	38 TO 100 SSU [21 cSt]	100 TO 250,000 SSU [55,000 cSt]	°F [°C]		
GHS 3 SR3-B ● GHS 3 SR4-B ■ †	300 [1135]	520	75 [5.2]	125 [8.7]	200 [14]	400° [204]	530 [240]	17.3
GHS 4 SR3-B ● GHS 4 SR4-B ■ †								
GHS 6 SR3-B ● † GHS 6 SR4-B ■ †								
GHS 3 SU3-B ● GHS 3 SU4-B ■ †								
GHS 4 SU3-B ● GHS 4 SU4-B ■ †	500 [1892]	350	50 [3.5]	100 [7]	150 [10.5]	500° [260]	837 [380]	21.3
GHS 6 SU3-B ● † GHS 6 SU4-B ■ †								
GHS 5 TU3-B ● GHS 5 TU4-B ■ †								
GHS 6 TU3-B ● GHS 6 TU4-B ■ †								

SEAL LIMITATIONS:				
● MECHANICAL SEAL OPTIONS	MAXIMUM INLET PRESSURE (PSI [BAR])		MAXIMUM VISCOSITY (SSU [cSt])	TEMPERATURE RANGE (°F [°C])
	NON-LUBRICATING LIQUID	LUBRICATING LIQUID		
STD	100 [7]	150 [10.5]	15,000 [3250]	0 to 400 [-17 to 204]
60D	200 [14]	350 [24]	25,000 [5417]	-75 to 500 [-60 to 260]
61J	100 [7]	200 [14]	15,000 [3250]	0 to 400 [-17 to 204]
■ PACKING	MAXIMUM INLET PRESSURE (PSI [BAR])		MAXIMUM VISCOSITY (SSU [cSt])	TEMPERATURE RANGE (°F [°C])
65P	400 [28]		250,000 [55,000]	-50 to 500 [-45 to 260]
STD	400 [28]		2,000,000 [440,000]	-50 to 650 [-45 to 344]

BUSHING LIMITATIONS:				
BUSHING OPTIONS	OPTIMAL VISCOSITY RANGE	TEMP LIMIT °F[°C]	ABRASIVES	CORROSIVES
STD, 40G	500 TO 100,000 SSU	400 [205]	NO	NO
40C, 40K, 70G	0.1 cPs TO 2,000,000 SSU	500 [260]	NO	YES *
40U, 41K, 70N	0.1 cPs TO 2,000,000 SSU	500 [260]	YES	YES *

- MECHANICAL SEAL
  - PACKING
  - † PORTS ARE COMPATIBLE WITH 125# ANSI CAST IRON FLANGES.
  - † 180° DEGREE HOUSING
- \* Note: Verify chemical compatibility

APPLICATION RECOMMENDATIONS:		
APPLICATION	OPTIONS REQUIRED (Select One From Each Row)	OPERATING LIMITATIONS
ASPHALT	25U, 25V, OR 25W (S SIZE) 25, 25A, 25C (T SIZE) 35J-35M 40G, 40K, 40U, 41K 70, 70G, 70N	TEMPERATURE: 500° MAX.

NOTE: PROPER PUMP APPLICATION REQUIRES CONSIDERATION OF ADDITIONAL FACTORS. PLEASE REVIEW APPLICATION GUIDE IN SECTION 500 OR CONSULT THE FACTORY.

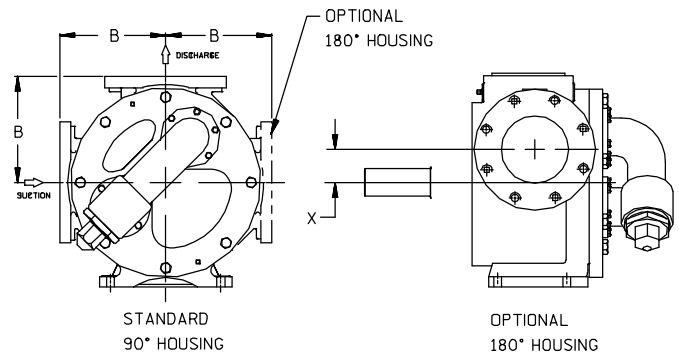
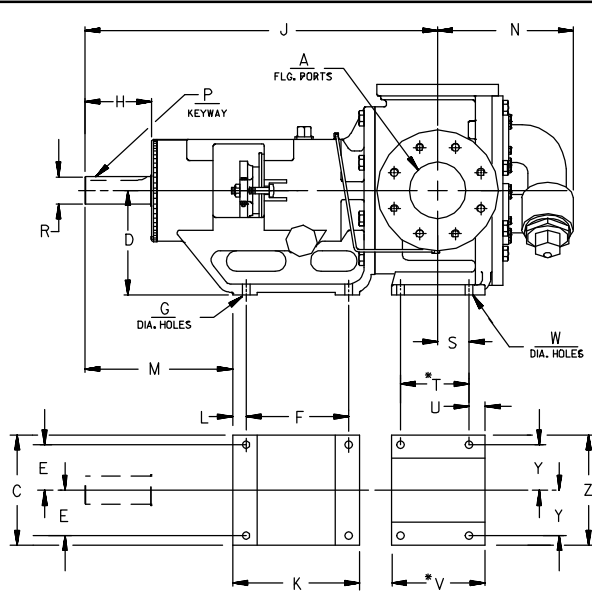

CAD FILE NO.: 16835

MODEL NUMBERS	PUMP DIMENSIONS - INCHES [MILLIMETERS]							
	A	B	C	D	E	F	G	H
GHS S	3"	7.75 [197]	10.00 [254]	8.75 [222]	4.12 [105]	4.00 [102]	.69 [18]	4.59 [117]
GHS S	4"	8.25 [210]	10.00 [254]	8.75 [222]	4.12 [105]	4.00 [102]	.69 [18]	4.59 [117]
GHS S	†6"	†9.00 [228]	10.00 [254]	8.75 [222]	4.12 [105]	4.00 [102]	.69 [18]	4.59 [117]
GHS T	5"	9.56 [243]	12.00 [305]	9.50 [241]	5.00 [127]	9.31 [236]	.69 [18]	6.06 [154]
GHS T	6"	9.62 [244] †9.75 [248]	12.00 [305]	9.50 [241]	5.00 [127]	9.31 [236]	.69 [18]	6.06 [154]

† 180° HOUSING

\* T SIZE ONLY.

MODEL NUMBERS	PUMP DIMENSIONS - INCHES [MILLIMETERS]															
	A	J	K	L	M	N	P	R	S	T	U	V	W	X	Y	Z
GHS S GHA S	3"	23.85 [606]	5.50 [140]	.85 [22]	11.37 [289]	12.49 [317]	.50 [13] x 3.37 [86]	2.00 [51]	3.61 [92]	—	1.79 [45]	—	.69 [18]	—	5.57 [141]	12.89 [327]
GHS S GHA S	4"	23.85 [606]	5.50 [140]	.85 [22]	11.37 [289]	12.49 [317]	.50 [13] x 3.37 [86]	2.00 [51]	3.61 [92]	—	1.79 [45]	—	.69 [18]	—	5.57 [141]	12.89 [327]
GHS S GHA S	†6"	23.85 [606]	5.50 [140]	.85 [22]	11.37 [289]	12.49 [317]	.50 [13] x 3.37 [86]	2.00 [51]	3.61 [92]	—	1.79 [45]	—	.69 [18]	3.00 [76]	5.57 [141]	12.89 [327]
GHS T GHA T	5"	32.00 [813]	11.54 [293]	1.22 [31]	13.40 [340]	12.35 [314]	.62 [16] x 4.62 [117]	2.50 [64]	2.88 [73]	6.25 [159]	1.44 [37]	8.50 [216]	.69 [18]	—	5.00 [127]	12.00 [305]
GHS T GHA T	6"	32.00 [813]	11.54 [293]	1.22 [31]	13.40 [340]	12.35 [314]	.62 [16] x 4.62 [117]	2.50 [64]	2.88 [73]	6.25 [159]	1.44 [37]	8.50 [216]	.69 [18]	—	5.00 [127]	12.00 [305]



# GHS & GHA

SEC. 545

PAGE 28

January 2010

## GRR REDUCER C-FLANGE FLEX DRIVE OPTIONS

(Drive Assy Number Includes Base, Coupling, Guard & Gear Reducer, But **NOT** the Motor)

PUMP MODEL	RPM @ 1750	RPM @ 1150	REDUCER <sup>①</sup>			FRAME	MTG.FT. OPTION REQ.	DRIVE ASSY NO.
			RATIO	MAX HP @ 1750	MAX HP @ 1150			
GHS S GHA S	500	329	3.50:1	20.00	13.20	254TC/256TC	STD	90453-004
	515	338	3.40:1	30.00	19.80	284TC/286TC	STD	90453-006
	530	348	3.30:1	60.00	39.60	324TC	STD	90453-008
	530	348	3.30:1	60.00	39.60	326TC	STD	90453-009
	530	348	3.30:1	60.00	39.60	364TC	STD	90453-010
	510	335	2.43:1	75.00	49.50	365TC	STD	90453-011
	450	296	3.89:1	20.00	13.20	254TC/256TC	STD	90453-020
	429	282	4.08:1	30.00	19.80	284TC/286TC	STD	90453-022
	432	284	4.05:1	60.00	39.60	324TC/326TC	STD	90453-024
	432	284	4.05:1	60.00	39.60	364TC	STD	90453-025
	425	279	4.12:1	60.00	39.60	365TC	STD	90453-026
	395	260	4.43:1	75.00	49.50	404TC	STD	90453-028
	343	225	5.10:1	100.00	66.00	254TC/256TC	STD	90453-030
	344	226	5.08:1	20.00	13.20	284TC/286TC	STD	90453-032
	355	233	4.93:1	30.00	19.80	324TC/326TC	STD	90453-034
	355	233	4.93:1	60.00	39.60	364TC	STD	90453-036
	283	186	6.19:1	60.00	39.60	254TC/258TC	STD	90453-042
	287	189	6.09:1	20.00	13.20	284TC	STD	90453-044
	287	189	6.09:1	30.00	19.80	286TC	STD	90453-045
	276	181	6.35:1	60.00	39.60	324TC	STD	90453-046
	276	181	6.35:1	60.00	39.60	326TC	STD	90453-047
	179	117	9.80:1	10.00	6.60	213TC	STD	90453-050
	206	135	8.50:1	20.00	13.20	254TC	STD	90453-052
	206	135	8.50:1	20.00	13.20	256TC	STD	90453-053
	198	130	8.83:1	30.00	19.80	284TC	STD	90453-054
	198	130	8.83:1	60.00	39.60	386TC	STD	90453-055
	199	131	8.78:1	60.00	39.60	324TC	STD	90453-056
	120	79	14.55:1	10.00	6.60	213TC	STD	90453-060
	125	82	14.00:1	30.00	19.80	254TC	STD	90453-062
	125	82	14.00:1	30.00	19.80	286TC	STD	90453-063
	125	82	14.00:1	30.00	19.80	284TC	STD	90453-064
	105	69	16.66:1	7.81	5.16	184TC	STD	90453-070
99	65	17.71:1	16.48	10.88	213TC	STD	90453-072	
98	65	17.81:1	26.41	17.43	254TC	STD	90453-074	
98	65	17.81:1	26.41	17.43	256TC	STD	90453-075	

<sup>①</sup> Listed reducer horsepower rated for Standard Service (8-10 hrs/day). For Light Service (3-5 hrs/day) multiply maximum rated horsepower by 1.1. For Heavy Service (16-24 hrs/day) multiply maximum rated horsepower by 0.9.

NOTE: CONSULT FACTORY FOR:  
HORSEPOWERS AND FRAMES NOT SHOWN.  
DRIP PAN BASES.



# GHS & GHA

SEC. 545

PAGE 29

January 2010

## GRR REDUCER C-FLANGE FLEX DRIVE OPTIONS

(Drive Assy Number Includes Base, Coupling, Guard & Gear Reducer, But **NOT** the Motor)

PUMP MODEL	RPM @ 1750	RPM @ 1150	REDUCER <sup>①</sup>			FRAME	MTG.FT. OPTION REQ.	DRIVE ASSY NO.
			RATIO	MAX HP @ 1750	MAX HP @ 1150			
GHS T GHA T	343	225	5.10:1	20.00	13.20	254TC/256TC	STD	90453-204
	344	226	5.08:1	30.00	19.80	284TC/286TC	STD	90453-206
	355	233	4.93:1	60.00	39.60	324TC/326TC	STD	90453-208
	355	233	4.93:1	60.00	39.60	364TC	STD	90453-210
	361	237	4.85:1	75.00	49.50	365TC	STD	90453-211
	331	213	5.29:1	100.00	66.00	405TSC	STD	90453-212
	308	202	5.68:1	200.00	100.00	444TSC	STD	90453-214
	308	202	5.68:1	200.00	100.00	445TSC	STD	90453-215
	283	186	6.19:1	20.00	13.20	254TC/256TC	STD	90453-220
	287	189	6.09:1	30.00	19.80	284TC/286TC	STD	90453-222
	276	181	6.35:1	60.00	39.60	324/326TC	STD	90453-224
	276	181	6.35:1	60.00	39.60	364TC	STD	90453-226
	273	179	6.42:1	75.00	49.50	365TC	STD	90453-227
	283	186	6.19:1	100.00	66.00	404TSC	STD	90453-228
	261	172	7.70:1	200.00	100.00	444TSC	STD	90453-230
	179	117	9.80:1	10.00	6.60	213TC	STD	90453-236
	206	135	8.50:1	20.00	13.20	254TC/256TC	STD	90453-238
	198	130	8.83:1	30.00	19.80	284TC	STD	90453-240
	198	130	8.83:1	30.00	19.80	286TC	STD	90453-241
	199	131	8.78:1	60.00	39.60	324TC	STD	90453-242
	199	131	8.78:1	60.00	39.60	326TC	STD	90453-243
	199	131	8.78:1	60.00	39.60	364TC	STD	90453-244
	185	122	9.46:1	75.00	49.50	365TC	STD	90453-245
	198	130	8.82:1	100.00	66.00	404TSC	STD	90453-246
	120	79	14.55:1	10.00	6.60	213TC	STD	90453-250
	125	82	14.00:1	30.00	19.80	254TC/256TC	STD	90453-252
	125	82	14.00:1	30.00	19.80	284TC/286TC	STD	90453-241
	126	83	13.92:1	54.47	35.95	324TC/326TC	STD	90453-256
	122	80	14.33:1	69.41	45.81	364TC	STD	90453-258
	105	69	16.66:1	7.81	5.16	184TC	STD	90453-264
	99	65	17.71:1	16.48	10.88	213TC	STD	90453-266
	98	65	17.81:1	26.41	17.43	254TC/256TC	STD	90453-268
	96	63	18.14:1	41.46	27.37	284TC/286TC	STD	90453-270
	96	63	18.14:1	41.46	27.37	324TC	STD	90453-272
104	68	16.86:1	59.17	39.05	326TC	STD	90453-273	

<sup>①</sup> Listed reducer horsepower rated for Standard Service (8-10 hrs/day). For Light Service (3-5 hrs/day) multiply maximum rated horsepower by 1.1. For Heavy Service (16-24 hrs/day) multiply maximum rated horsepower by 0.9.

NOTE: CONSULT FACTORY FOR: HORSEPOWERS AND FRAMES NOT SHOWN. DRIP PAN BASES.

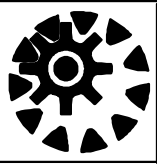

# PERFORMANCE CURVES

## SPEED VS. CAPACITY/HORSEPOWER

# SR

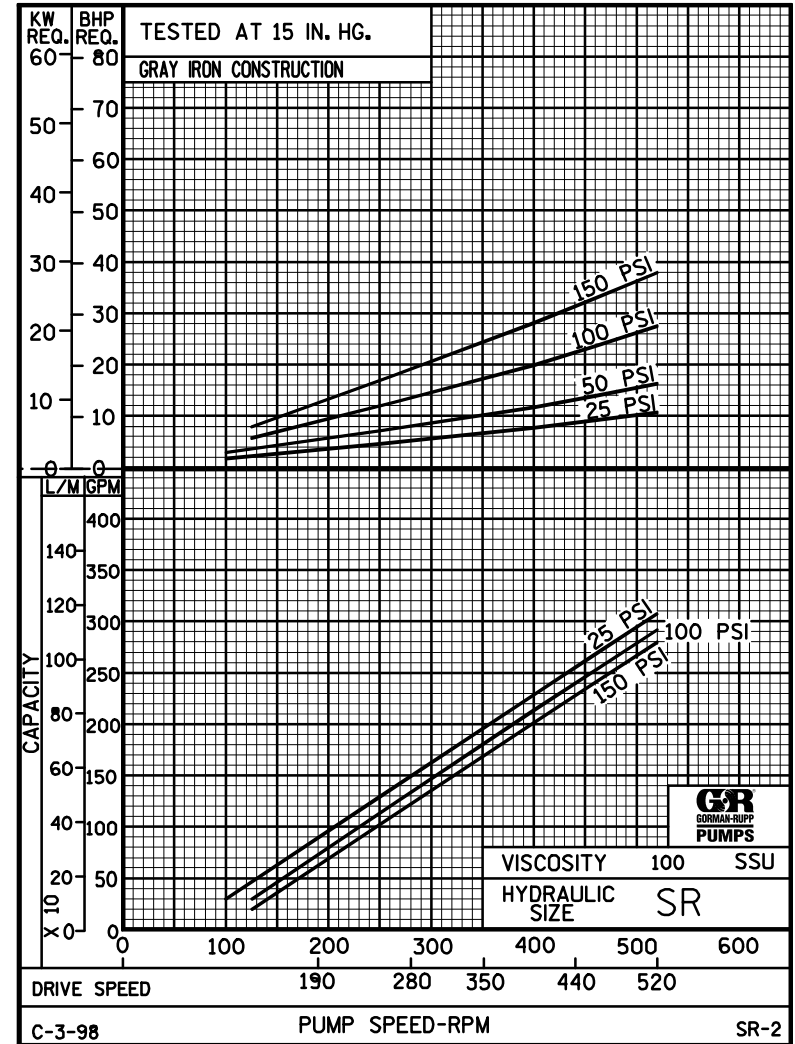
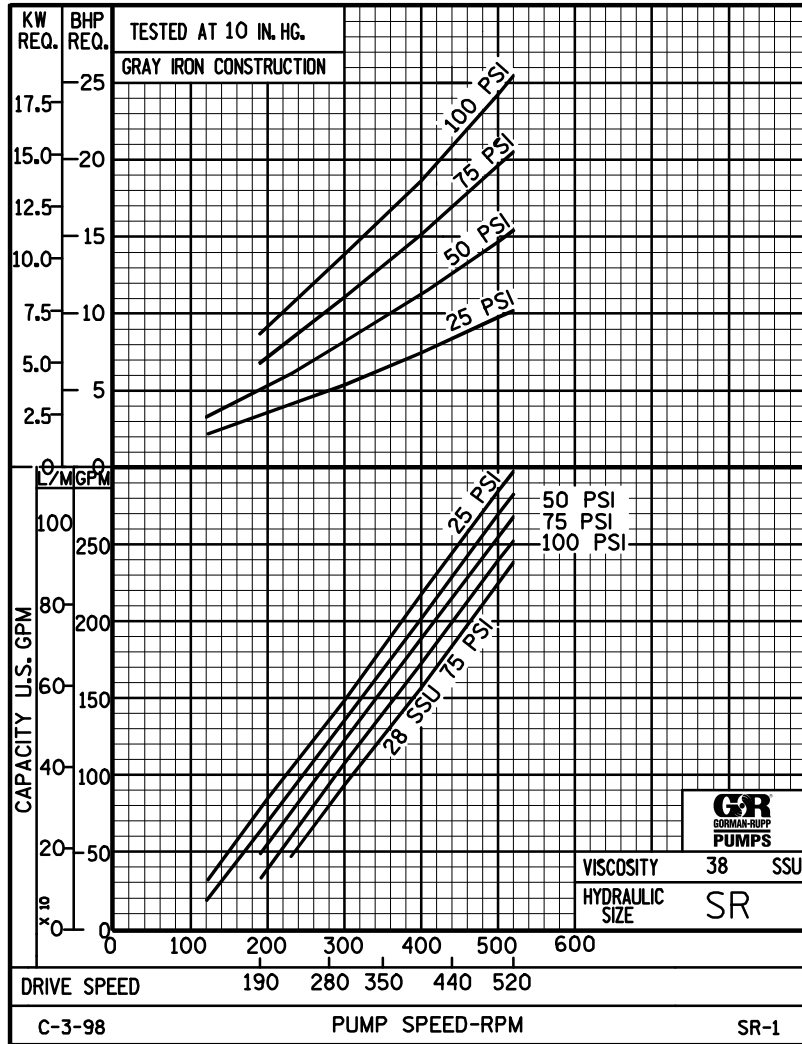
 Hydraulic Size

THE GORMAN-RUPP COMPANY • MANSFIELD, OHIO  
GORMAN-RUPP OF CANADA LIMITED • ST. THOMAS, ONTARIO, CANADA

Printed in U.S.A.

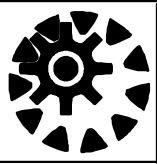

# PERFORMANCE CURVES

## SPEED VS. CAPACITY/HORSEPOWER

# SR

Hydraulic Size

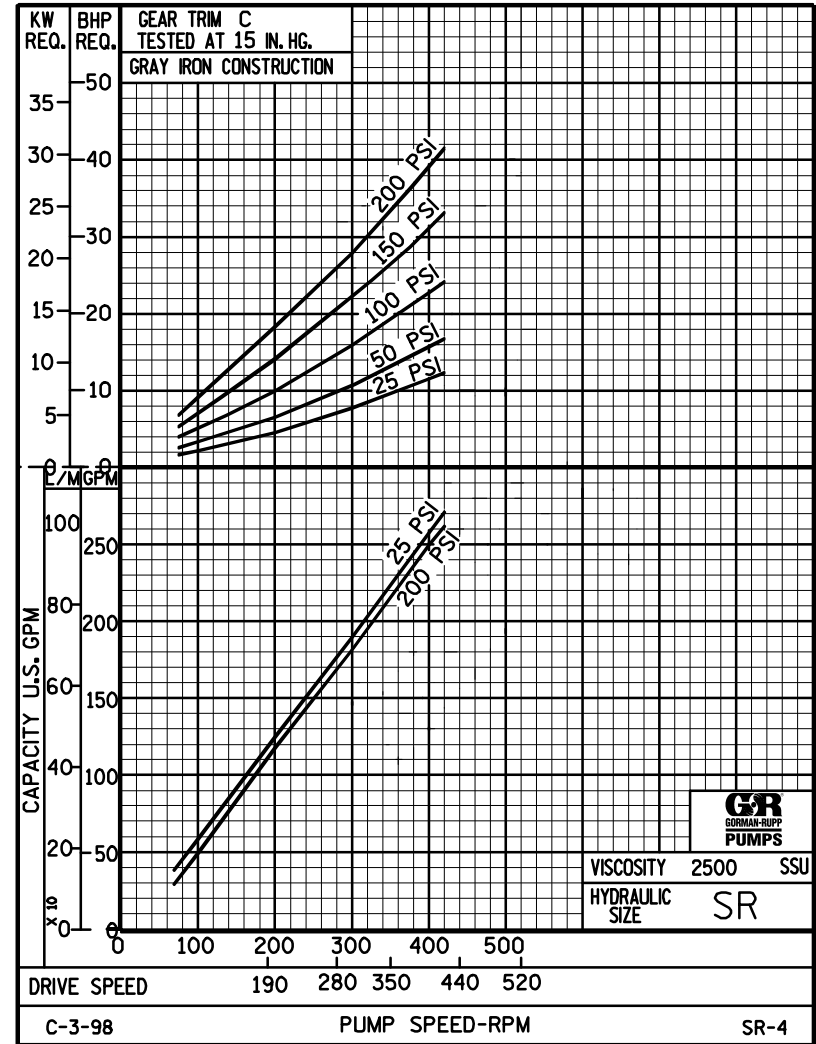
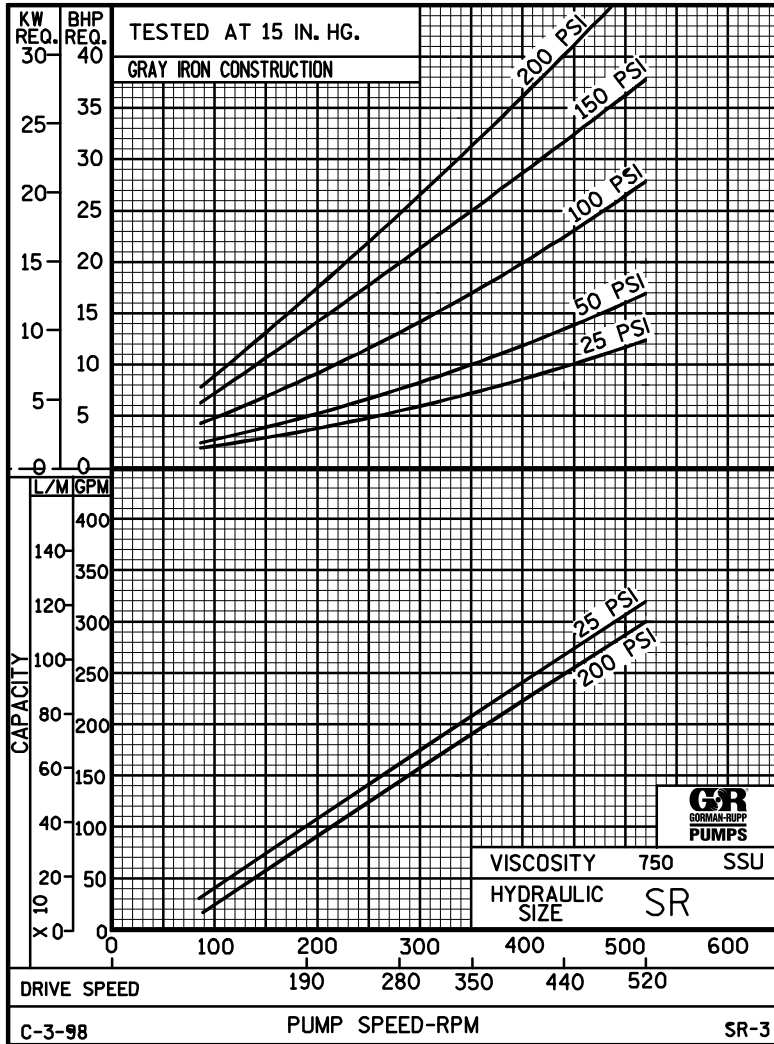

THE GORMAN-RUPP COMPANY • MANSFIELD, OHIO  
GORMAN-RUPP OF CANADA LIMITED • ST. THOMAS, ONTARIO, CANADA

Printed in U.S.A.





# PERFORMANCE CURVES

## SPEED VS. CAPACITY/HORSEPOWER

# SR

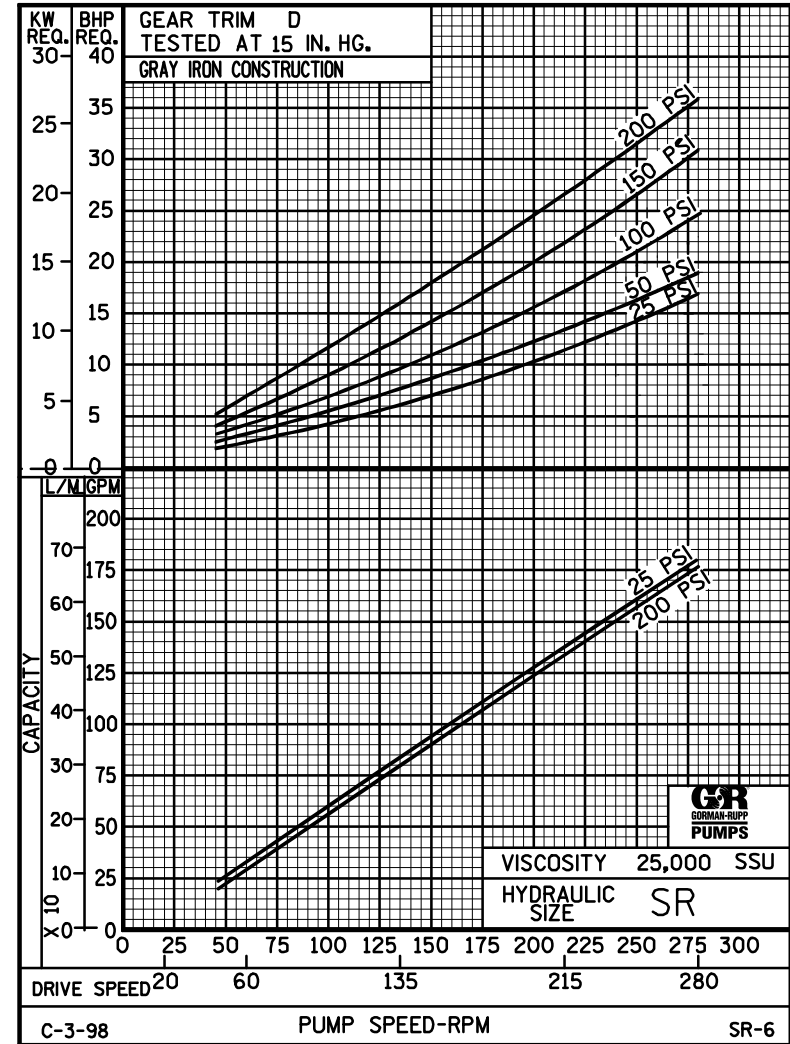
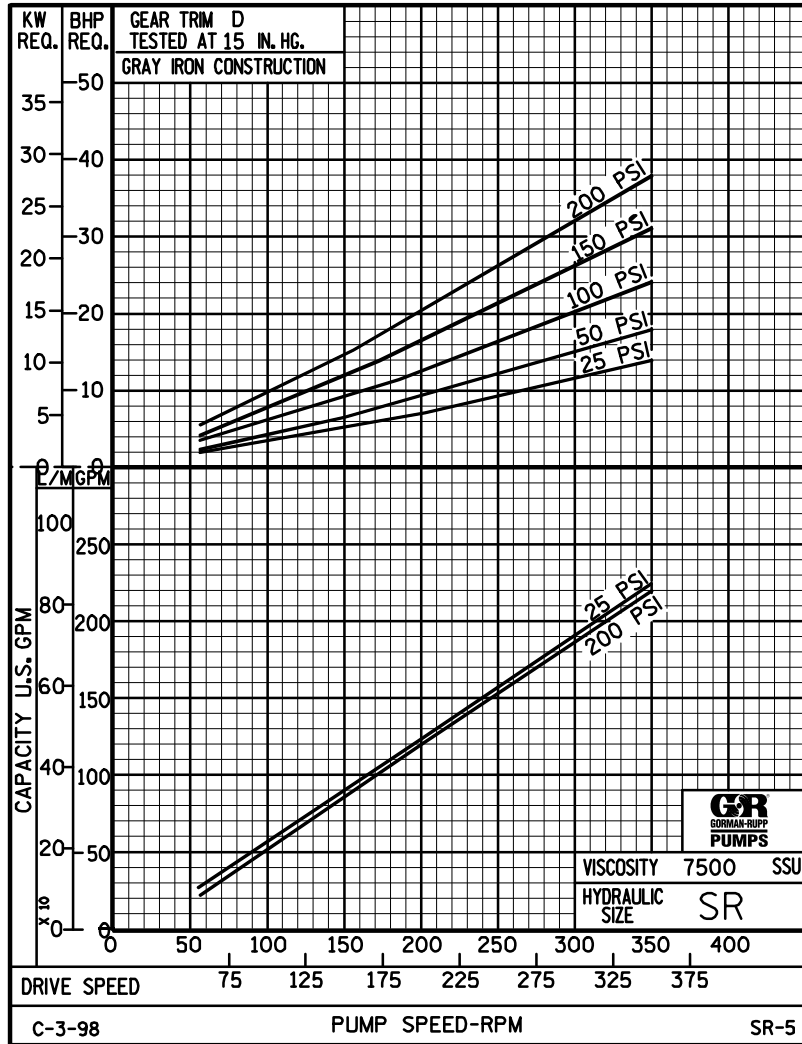
 Hydraulic Size

THE GORMAN-RUPP COMPANY • MANSFIELD, OHIO  
GORMAN-RUPP OF CANADA LIMITED • ST. THOMAS, ONTARIO, CANADA

Printed in U.S.A.

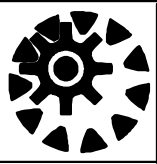

# PERFORMANCE CURVES

## SPEED VS. CAPACITY/HORSEPOWER

# SR

Hydraulic Size

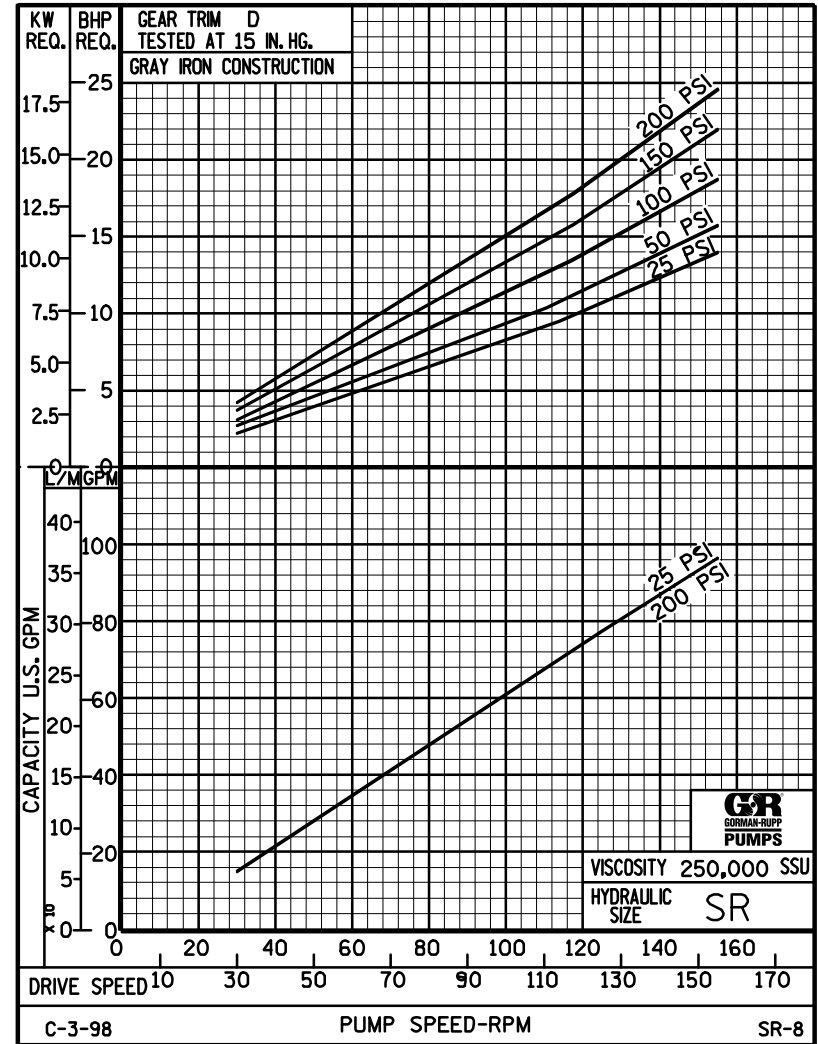
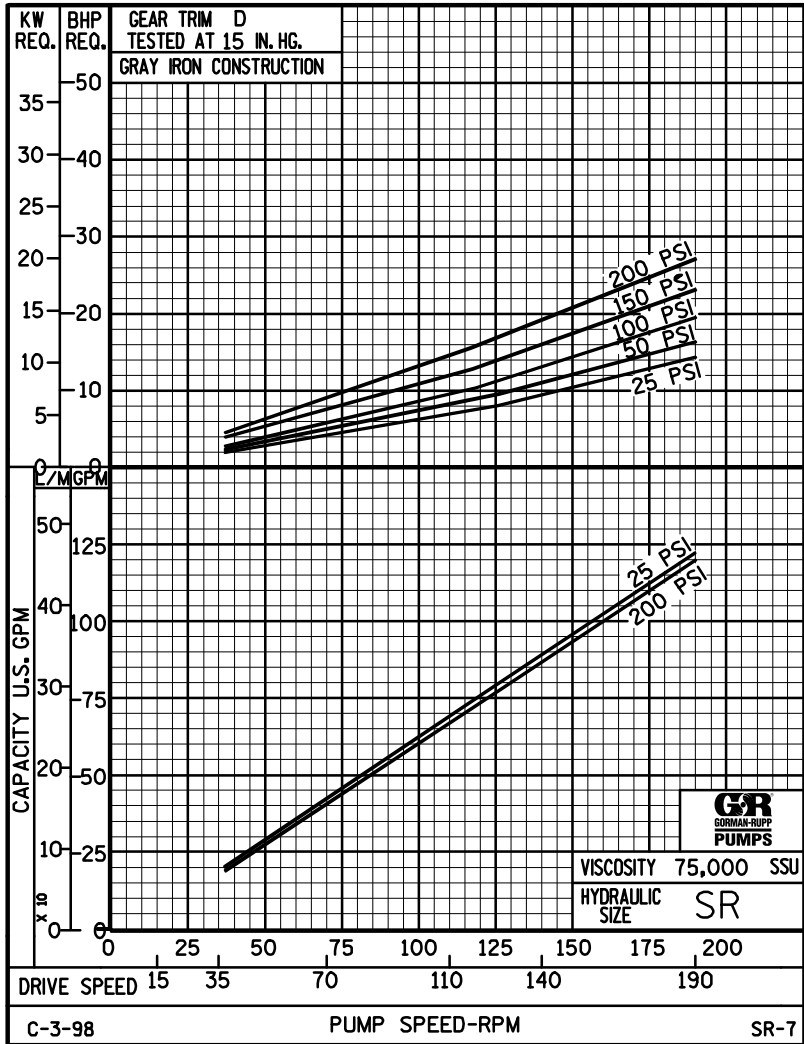

THE GORMAN-RUPP COMPANY • MANSFIELD, OHIO  
 GORMAN-RUPP OF CANADA LIMITED • ST. THOMAS, ONTARIO, CANADA

Printed in U.S.A.