

**MEDIUM DUTY STANDARD;  
 D, G, J, N & R SIZE  
 ROTARY GEAR PUMP**

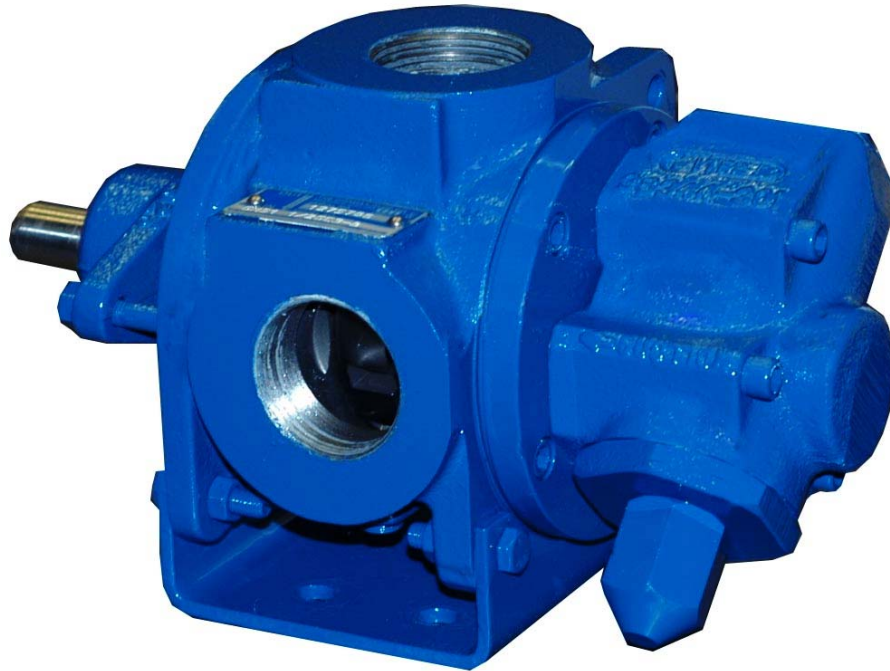

The GMS series is designed for applications in the operating ranges noted below. These units are available with head and backhead jackets (R size only) for temperature control, carbon graphite bushings for low viscosity liquids, silicon carbide bushings for wear resistance, and carbide, positive drive or packing seals for viscous sealing.

For continuous service, or for handling more viscous liquids, see the heavy duty GHS section.

For belt driven applications, select an extended shaft option and consult factory for availability of drive assembly. A pedestal bearing is required for belt driven applications.

**FEATURES**

*150 PSI CAPABILITY*  
*SELF-CONTAINED, NO EXTERNAL BEARING REQUIRED (UNLESS BELT DRIVEN)*  
*HIGH STRENGTH, COMPUTER PROFILED GEARING FOR QUIET OPERATION*  
*THRUST CONTROLLED PUMP ELEMENTS*  
*EXCEPTIONAL SEAL VERSATILITY*

**OPERATING RANGE**

CAPACITY (GPM) : (3 TO 265)  
 [LPM] : [11 TO 930]  
 PRESSURE (PSI) : (0 TO 150)  
 [BAR] : [0 TO 10.3]  
 VISCOSITY (SSU) : (28 TO 250,000)  
 [cSt] : [1 TO 55,000]  
 TEMPERATURE (F) : (-60° TO 450°)  
 [C] : [-51° TO 230°]

**APPLICATIONS**

- ★ BOOSTER SERVICE
- ★ CIRCULATING
- ★ FILTERING
- ★ LUBRICATING
- ★ TRANSFERRING

EXT.	ROTOR & IDLER	HOUSING PORTS	BUSHINGS	IDLER PIN	SHAFT	SHAFT SEALING		ROT.	INTERNAL RELIEF VALVE	
						MECH. SEAL ●	PACKING ■		MATERIAL	SETTING
CAST IRON	HIGH STRENGTH IRON	90° TAPPED	BRONZE	HARDENED STEEL		FLUORO <sup>①</sup> CARBON, NI-RESIST	PTFE <sup>②</sup> GRAPHITE	C.W.	DUCTILE IRON	75 PSI [5 BAR]

## Standard Models

**G M S 1 DC 3 - B**  
 GEAR DUTY DESIGN PORT SIZE HYDRAULIC SEAL STYLE

MODEL NUMBER	NOM. CAPACITY - SPEED				MAXIMUM				SHIPPING DATA	
	MAXIMUM		ALTERNATIVE		DIFFERENTIAL PRESSURE-PSI [BAR]			TEMP.	Weight	Volume
	GPM	RPM	GPM	RPM	BELOW	38 TO	100 TO	°F	LBS	CU. FT.
	[LPM]	60 Hz [50 Hz]	[LPM]	60 Hz [50 Hz]	38 SSU [4 cSt]	100 SSU [21 cSt]	250,000 SSU [55,000 cSt]	[°C]	[KG]	FT.
<b>GMS 1DC 3-B</b> ● <b>GMS 1DC 4-B</b> ■	9 [28]		6 [19]						19 [8,6]	0.6
<b>GMS 1DE 3-B</b> ● <b>GMS 1DE 4-B</b> ■	11 [35]		7 [22]						19 [8,6]	0.6
<b>GMS 1-1/2 GC 3-B</b> ● <b>GMS 1-1/2 GC 4-B</b> ■	16 [50]		10 [32]						32 [14,5]	2.9
<b>GMS 2 GC 3-B</b> ● <b>GMS 2 GC 4-B</b> ■									32 [14,5]	2.9
<b>GMS 1-1/2 GF 3-B</b> ● <b>GMS 1-1/2 GF 4-B</b> ■	23 [73]	1750 [1460]	15 [47]	1150 [960]				400 [205]	32 [14,5]	2.9
<b>GMS 2 GF 3-B</b> ● <b>GMS 2 GF 4-B</b> ■					50 [3]	75 [5]	150 [10.3]		32 [14,5]	2.9
<b>GMS 1-1/2 GH 3-B</b> ● <b>GMS 1-1/2 GH 4-B</b> ■	31 [98]		20 [63]						32 [14,5]	2.9
<b>GMS 2 GH 3-B</b> ● <b>GMS 2 GH 4-B</b> ■								450 [230]	32 [14,5]	2.9
<b>GMS 1-1/2 GJ 3-B</b> ● <b>GMS 1-1/2 GJ 4-B</b> ■	38 [120]		25 [79]						32 [14,5]	2.9
<b>GMS 2 GJ 3-B</b> ● <b>GMS 2 GJ 4-B</b> ■									32 [14,5]	2.9
<b>GMS 2 JG 3-B</b> ● <b>GMS 2 JG 4-B</b> ■									83 [37,6]	2.9
<b>GMS 2-1/2 JG 3-B</b> ● <b>GMS 2-1/2 JG 4-B</b> ■	33 [126]	960 [960]	30 [95]	870 [725]					83 [37,6]	2.9
<b>GMS 3 JG 3-B</b> ● <b>GMS 3 JG 4-B</b> ■									83 [37,6]	2.9
STANDARD MODELS CONT.										

**NOTE:** RECOMMENDED PORT SIZES ARE SHOWN IN **BOLDFACE**. EXAMPLE: **GMS 2GJ3-B**

● MECHANICAL SEAL

■ PACKING/LIPSEAL

① DUPONT VITON<sup>®</sup> OR EQUIVALENT

② DUPONT TEFLON<sup>®</sup> OR EQUIVALENT

**THE GORMAN-RUPP COMPANY • MANSFIELD, OHIO**

GORMAN-RUPP OF CANADA LIMITED • ST. THOMAS, ONTARIO, CANADA

# Standard Models Cont'd

MODEL NUMBER	NOM. CAPACITY - SPEED				MAXIMUM				SHIPPING DATA	
	MAXIMUM		ALTERNATIVE		DIFFERENTIAL PRESSURE-PSI [BAR]			TEMP.	Weight	Volume
	GPM [LPM]	RPM 60 Hz [50 Hz]	GPM [LPM]	RPM 60 Hz [50 Hz]	BELOW 38 SSU [4 cSt]	38 TO 100 SSU [21 cSt]	100 TO 250,000 SSU [55,000 cSt]	°F [°C]		
GMS 2 JJ 3-B ● GMS 2 JJ 4-B ■	47 [177]	960 [960]	42 [133]	870 [725]	50 [3]	75 [5]	150 [10.3]	● 400 [205]	83	2.9
GMS 2-1/2 JJ 3-B ● GMS 2-1/2 JJ 4-B ■									83 [37,6]	2.9
GMS 3 JJ 3-B ● GMS 3 JJ 4-B ■									83 [37,6]	2.9
GMS 2 JL 3-B ● GMS 2 JL 4-B ■	64 [243]	960 [960]	58 [183]	870 [725]	50 [3]	75 [5]	150 [10.3]	● 400 [205]	83	2.9
GMS 2-1/2 JL 3-B ● GMS 2-1/2 JL 4-B ■									83 [37,6]	2.9
GMS 3 JL 3-B ● GMS 3 JL 4-B ■									83 [37,6]	2.9
GMS 2 JP 3-B ● GMS 2 JP 4-B ■	89 [338]	960 [960]	81 [256]	870 [725]	50 [3]	75 [5]	150 [10.3]	● 400 [205]	83	2.9
GMS 2-1/2 JP 3-B ● GMS 2-1/2 JP 4-B ■									83 [37,6]	2.9
GMS 3 JP 3-B ● GMS 3 JP 4-B ■									83 [37,6]	2.9
GMS 1-1/2 NK 3-B ● GMS 1-1/2 NK 4-B ■	90 [283]	960 [960]	60 [189]	870 [725]	50 [3]	75 [5]	150 [10.3]	■ 450 [230]	109	2.9
GMS 2 NK 3-B ● GMS 2 NK 4-B ■									109 [49]	2.9
GMS 2-1/2 NK 3-B ● GMS 2-1/2 NK 4-B ■									109 [49]	2.9
GMS 3 NK 3-B ● GMS 3 NK 4-B ■	120 [378]	960 [960]	80 [252]	870 [725]	50 [3]	75 [5]	150 [10.3]	■ 450 [230]	109	2.9
GMS 2 NM 3-B ● GMS 2 NM 4-B ■									109 [49]	2.9
GMS 2-1/2 NM 3-B ● GMS 2-1/2 NM 4-B ■									109 [49]	2.9
GMS 3 NM 3-B ● GMS 3 NM 4-B ■	150 [473]	960 [960]	99 [312]	870 [725]	50 [3]	75 [5]	150 [10.3]	■ 450 [230]	109	2.9
GMS 2 NP 3-B ● GMS 2 NP 4-B ■									109 [49]	2.9
GMS 2-1/2 NP 3-B ● GMS 2-1/2 NP 4-B ■									109 [49]	2.9
GMS 3 NP 3-B ● GMS 3 NP 4-B ■									109	2.9

STANDARD MODELS CONT.

- MECHANICAL SEAL
- PACKING/LIPSEAL

NOTE: RECOMMENDED PORT SIZES ARE SHOWN IN **BOLDFACE**. EXAMPLE: **GMS 2GJ 3-B**

**THE GORMAN-RUPP COMPANY • MANSFIELD, OHIO**  
 GORMAN-RUPP OF CANADA LIMITED • ST. THOMAS, ONTARIO, CANADA

MODEL NUMBER	NOM. CAPACITY - SPEED				MAXIMUM				SHIPPING DATA							
	MAXIMUM		ALTERNATIVE		DIFFERENTIAL PRESSURE - PSI [BAR]			TEMP.	Weight LBS [KG]	Volume CU. FT.						
	GPM [LPM]	RPM 60 Hz [50 Hz]	GPM [LPM]	RPM 60 Hz [50 Hz]	BELOW 38 SSU [4 cSt]	38 TO 100 SSU [21 cSt]	100 TO 250,000 SSU [55,000 cSt]	°F [°C]								
GMS 2 RM 3-B ● GMS 2 RM 4-B ■	153 [542]	640 [600]	115 [362]	480 [400]				● 400 [205]	233 [106]	10.7						
GMS 2-1/2 RM 3-B ● † GMS 2-1/2 RM 4-B ■ †									233 [106]	10.7						
<b>GMS 3 RM 3-B ● †</b> <b>GMS 3 RM 4-B ■ †</b>									233 [106]	10.7						
GMS 4 RM 3-B ● † GMS 4 RM 4-B ■ †									233 [106]	10.7						
GMS 2-1/2 RP 3-B ● † GMS 2-1/2 RP 4-B ■ †									233 [106]	10.7						
<b>GMS 3 RP 3-B ● †</b> <b>GMS 3 RP 4-B ■ †</b>	190 [678]	640 [600]	143 [451]		50 [3]	75 [5]	150 [10.3]	● 400 [205]	233 [106]	10.7						
GMS 4 RP 3-B ● † GMS 4 RP 4-B ■ †	233 [106]								10.7							
GMS 2-1/2 RR 3-B ● † GMS 2-1/2 RR 4-B ■ †	228 [804]								170 [536]					■ 450 [230]	233 [106]	10.7
GMS 3 RR 3-B ● † GMS 3 RR 4-B ■ †															233 [106]	10.7
<b>GMS 4 RR 3-B ● †</b> <b>GMS 4 RR 4-B ■ †</b>															233 [106]	10.7
GMS 3 RS 3-B ● † GMS 3 RS 4-B ■ †	265 [930]	196 [618]						233 [106]	10.7							
<b>GMS 4 RS 3-B ● †</b> <b>GMS 4 RS 4-B ■ †</b>								233 [106]	10.7							

NOTE: RECOMMENDED SIZES ARE SHOWN IN **BOLDFACE**. EXAMPLE: **GMS 2GJ 3-B**

† PORTS ARE COMPATIBLE WITH 125# ANSI CAST IRON FLANGES. ALL OTHER PORTS ARE TAPPED NPT FOR ANSI PIPE. OPTIONAL [DIN] FLANGES OR TAPPED [BSP] PORTS AVAILABLE FOR EXPORT MARKET.

**THE GORMAN-RUPP COMPANY • MANSFIELD, OHIO**  
GORMAN-RUPP OF CANADA LIMITED • ST. THOMAS, ONTARIO, CANADA

# Basic Pump Dimensions



CAD FILE NO.: 16530

MODEL NUMBERS	PUMP DIMENSIONS - INCHES [MILLIMETERS]															
	A	B	C	D	E	F	G	H	J	K	L	M	N	P	Q	
GMS D	1"	2.50* [64]	4.00 [102]	3.50* [89]	1.62 [41]	1.62 [41]	.41 [10]	1.44 [36]	5.81 [148]	3.24 [82]	.89 [23]	3.99 [101]	4.97 [126]	.19 [5] x 1.00 [25]	.62 [16]	
		2.75† [70]		4.50 [114]												5.25 [133]
		3.19 [81]														
		4.00† [102]														
GMS G	1-1/2"	3.50* [89]	4.88 [124]	3.50* [89]	1.62 [41]	1.62 [41]	.41 [10]	1.64 [42]	5.96 [151]	3.85 [98]	.76 [19]	4.14 [105]	5.70 [145]	.19 [5] x 1.25 [32]	.75 [19]	
		3.75† [95]		4.50 [114]												5.25 [133]
	4.00 [102]			6.25 [159]												
	4.00† [102]															
GMS J	2"	4.50* [114]	6.88 [175]	5.25* [133]	2.88 [73]	3.00 [76]	.44 [11]	2.50 [64]	9.91 [252]	5.71 [145]	1.18 [30]	7.31 [186]	8.50 [216]	.25 [6] x 2.00 [51]	1.00 [25]	
		5.00† [127]		6.25 [159]												7.00 [178]
	6.00† [152]			7.00 [178]												
	6.31† [160]			8.00 [203]												
GMS N	1-1/2"	5.12* [130]	8.00 [203]	4.50 [114]	2.88 [73]	4.25 [108]	.44 [11]	2.50 [64]	9.20 [234]	6.42 [163]	1.12 [28]	6.12 [155]	7.59 [193]	.25 [6] x 2.00 [51]	1.25 [32]	
				5.25* [133]												6.25 [159]
	7.19† [183]															8.00 [203]
GMS R	2"	8.50* [216]	10.25 [260]	7.00* [178]	3.75 [95]	5.75 [146]	.53 [13]	3.03 [77]	12.50 [318]	8.43 [214]	1.38 [35]	8.35 [212]	11.31 [287]	.38 [10] x 2.25 [57]	1.50 [38]	
	7.19† [183]															

\* STANDARD DIMENSION

† 180° HOUSING

‡ PORTS ARE COMPATIBLE WITH 125\* OR 250\* ANSICAST IRON FLANGES. ALL OTHER PORTS ARE TAPPED NPT FOR ANSI PIPE. OPTIONAL (DIN) FLANGES OR TAPPED (BSP) PORTS AVAILABLE FOR EXPORT MARKET.

**THE GORMAN-RUPP COMPANY • MANSFIELD, OHIO**  
**GORMAN-RUPP OF CANADA LIMITED • ST. THOMAS, ONTARIO, CANADA**



## DIRECT FLEX DRIVE OPTION DIMENSIONS



CAD FILE NO.: 16567

PUMP MODEL	PUMP DIMENSIONS - INCHES[MILLIMETERS]															
	A	B	MOTOR FRAME	C	D	E	F	G	H	J	K	L	M	N		
GMS D	1"	2.50*	56 (H)	2.00	3.50*	4.44	8.88	10.14	.56	20.04	19.25	25.25	3.00	4.97		
		[64]	143T/145T	[51]	[89]	[113]	[228]	[258]		[509]	[489]	[841]	[78]			
		2.75 †	182T/184T	4.00	4.50	7.75	15.50	17.50		[14]	26.41	23.50	33.50		5.00	[126]
		[70]	213T/215T	[102]	[114]	[197]	[394]	[445]		[671]	[597]	[851]	[127]			
GMS G	1- 1/2"	3.50*	56 (H)	2.00	3.50*	4.44	8.88	10.14	.56	20.20	19.25	25.25	3.00	5.71		
		[89]	143T/145T	[51]	[89]	[113]	[228]	[258]		[513]	[489]	[841]	[76]			
	2"	3.75 †	182T/184T	4.00	4.50	7.75	15.50	17.50	[14]	26.57	23.50	33.50	5.00	[145]		
		[95]	213T/215T	[102]	[114]	[197]	[394]	[445]	[675]	[597]	[851]	[127]				
GMS J	2"	4.50*	182T/184T	4.00	4.50	9.50	19.00	21.00	.69	36.16	35.50	45.50	5.00	8.49		
		[114]	213T/215T		[114]										[133]	
	2- 1/2"	5.00 †	254T/256T	6.25	9.50	19.00	21.00	[18]	[918]	[902]	[1156]	[127]	[216]			
		[127]	284T/286T	[159]	[241]	[483]	[533]	[170]								
GMS N	1- 1/2"	5.12*	182T/184T	4.00	4.50	9.50	19.00	21.00	.69	35.44	35.50	45.50	5.00	7.59		
		[130]	213T/215T		[133]										[241]	[483]
	2"	7.19 †	254T/256T	7.00	9.50	19.00	21.00	[18]	[900]	[902]	[1158]	[127]	8.70			
		[183]	284T/286T	[178]	[241]	[483]	[533]	[170]	[18]	[900]	[902]	[1158]	[127]	*		
3"	8.00	324T/326T	8.00	9.50	19.00	21.00	[18]	[900]	[902]	[1158]	[127]	8.70				
	[203]	324T/326T	[203]	[241]	[483]	[533]	[170]	[18]	[900]	[902]	[1158]	[127]	*			

\* STANDARD DIMENSION

† 180° HOUSING

┆ PORTS ARE COMPATIBLE WITH 125# OR 250# ANSICAST IRON FLANGES. ALL OTHER PORTS ARE TAPPED NPT FOR ANSIPPIPE. OPTIONAL (DIN) FLANGES OR TAPPED (BSP) PORTS AVAILABLE FOR EXPORT MARKET.

## DIRECT FLEX DRIVE OPTIONS

Drive Assembly Number Includes Base, Coupling & Guard, But **Not** the Motor



CAD FILE NO.: 16567

PUMP MODEL NUMBER	60 HZ. RPM	FRAME	MTG. FT. OPTION REQ.	DRIVE ASSY NO.
<b>GMS D</b>	1750 1150 850	56/56H	STD	90251-082
		143T/145T	STD	90251-084
		182T/184T	80F	90251-090
		213T/215T	80J	90251-094
<b>GMS G</b>	1750 1150 850	56/56H	STD	90251-160
		143T/145T	STD	90251-162
		184	80F	90221-156
		182T/184T	80F	90251-168
		213T/215T	80J	90251-176
<b>GMS J</b>	850	254T	80P	90251-180
		182T/184T	80F	90251-310
		213T/215T	STD	90251-318
		254T/256T	80P	90251-330
<b>GMS N</b>	850	284T/286T	80S	90251-338
		254T/256T	80P	90251-394
		284T/286T	80S	90251-402
		324T/326T	80V	90251-410

NOTE: CONSULT FACTORY FOR OPTIONS NOT SHOWN.



## GRR REDUCER C-FLANGE FLEX DRIVE OPTION DIMENSIONS (56C - 215TC Frame Size Range)



CAD FILE NO.: 16573

PUMP MODEL	PUMP DIMENSIONS															
	A	B	MOTOR FRAME	C	D	E	F	G	H	J	K	L	M	N		
GMS D	1"	2.50 * [64]	56C	2.00 [51]	3.50 * [89]	6.50 [165]	13.00 [330]	15.00 [381]	.56 [14]	19.98 [507]	25.50 [648]	31.50 [800]	3.00 [76]	4.98 [126]		
		2.75 † [70]	184C			7.31 [186]	14.62 [371]	16.62 [422]		26.68 [678]	37.25 [946]	43.25 [1098]				
		3.19 † [61]	143TC/145TC													
		4.00 † [102]	182TC/184TC													
			213TC/215TC													
GMS G	1-1/2"	3.50 * [89]	56C	2.00 [51]	3.50 * [89]	6.50 [165]	13.00 [330]	15.00 [381]	.58 [14]	20.11 [511]	25.50 [648]	31.50 [800]	3.00 [76]	5.72 [145]		
		3.75 † [95]	184C			7.31 [186]	14.62 [371]	16.62 [422]		26.81 [681]	37.25 [946]	43.25 [1098]				
	4.00 † [102]	143TC/145TC														
	4.00 † [102]	182TC/184TC	4.50 [114]													
			213TC/215TC		5.25 [133]											
GMS J	2"	4.50 * [114]	182TC/184TC	2.00 [51]	4.50 [114]	7.31 [186]	14.62 [371]	16.62 [422]	.56 [14]	30.20 [767]	32.00 [813]	38.00 [965]	3.00 [76]	8.50 [216]		
	2-1/2"	5.00 † [127]														
		6.00 † [152]	213TC/215TC								5.25 * [133]					
	3"	6.31 † [160]														
GMS N	1-1/2"		182TC/184TC	2.00 [51]	4.50 [114]	7.31 [186]	14.62 [371]	16.62 [422]	.56 [14]	* 29.48 [749]			3.00 [76]	7.59 [193]		
	2"	5.12 * [130]														
	2-1/2"	7.19 † [183]	213TC/215TC							5.25 * [133]						
	3"									30.59 [777]				*		

\* STANDARD DIMENSION

† 180° HOUSING

‡ PORTS ARE COMPATIBLE WITH 125# OR 250# ANSI/AST IRON FLANGES. ALL OTHER PORTS ARE TAPPED NPT FOR ANSI PIPE. OPTIONAL (DIN) FLANGES OR TAPPED (BSP) PORTS AVAILABLE FOR EXPORT MARKET.





## GRR REDUCER C-FLANGE FLEX DRIVE OPTION DIMENSIONS (213TC - 326TC Frame Size Range)

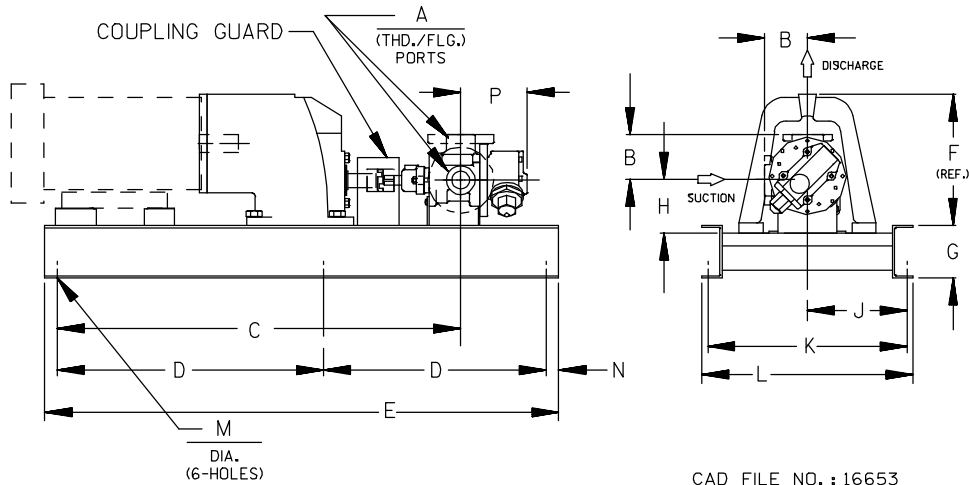

CAD FILE NO. : 16653

PUMP MODEL	PUMP DIMENSIONS														
	A	B	MOTOR FRAME	C	D	E	F	G	H	J	K	L	M	N	P
GMS J	2"	4.50 * [114]	213TC/215TC	41.57 [1056]	23.00 [584]	56.00 [1422]	12.14 [308]								
	2 1/2"	5.00 † [127]	254TC/256TC	42.03 [1068]				8.00 [203]	6.25 [159]	10.12 [257]	20.25 [514]	22.50 [572]	.69 [18]	5.00 [127]	8.49 [216]
		6.00 † [152]	254TC/256TC	44.76 [1137]	24.12 [613]	58.25 [1480]									
	3"	6.31 † [160]	284TC/286TC	46.98 [1183]	25.75 [654]	61.50 [1562]	14.91 [378]								
GMS N	1 1/2"		213TC/215TC	41.98 [1066]											
	2"	5.12 * [130]	213TC/215TC	40.85 [1038]	23.00 [584]	56.00 [1422]	12.14 [308]								
				254TC/256TC	42.42 [1077]				8.00 [152]	6.25 [159]	10.12 [257]	20.25 [514]	22.50 [572]	.69 [18]	5.00 [127]
	2 1/2"	7.19 † [183]	254TC/256TC	41.31 [1049]	24.12 [613]	58.25 [1480]									8.70 [221]
3"		284TC/286TC	45.15 [1147]	25.75 [654]	61.50 [1562]	14.91 [379]								*	
GMS R	2"		184TC	38.50 [978]	22.62 [575]	55.25 [11403]	10.80 [274]								
	2 1/2"	6.50 * [165]	213TC/215TC	43.80 [1112]	25.28 [642]	60.56 [1538]	12.26 [311]	8.00 [203]	7.00 [178]	10.38 [264]	20.75 [527]	23.00 [584]	.69 [18]	5.00 [127]	11.31 [287]
				213TC/215TC	43.80 [1112]	25.28 [642]	60.56 [1538]	12.26 [311]							
	3"	7.19 † [183]	254TC/256TC	48.75 [1238]	27.75 [705]	65.50 [1664]	16.04 [407]								
4"		284TC/286TC													

\* STANDARD DIMENSION

† 180° HOUSING

‡ PORTS ARE COMPATIBLE WITH 125\* OR 250\* ANSI/AST IRON FLANGES. ALL OTHER PORTS ARE TAPPED NPT FOR ANSI PIPE. OPTIONAL (DIN) FLANGES OR TAPPED (BSP) PORTS AVAILABLE FOR EXPORT MARKET.

**CROSS REFERENCE OF MOTOR FRAMES TO GEARBOX RATIOS:**

- Ⓐ 2:1, 3.15:1 (15 hp Only), 2.5:1
- Ⓑ 3.15:1 (20 hp Only), 4:1, 5:1
- Ⓒ 2.5:1, 4:1
- Ⓓ 3.15:1, 5:1

**REFERENCE: PUMP FOOT BRACKET OPTIONS**

MOTOR FRAME	CENTER HEIGHT	PUMP OPTION
213TC thru 286TC	6.25"	80P ("J" & "N" Size Only)
182TC thru 326TC	7.00"	STD ("R" Size Only)



# GMS

SEC. 525

PAGE 19  
January 2010

## GRR REDUCER C-FLANGE FLEX DRIVE OPTIONS

(Drive Assembly Number Includes Base, Coupling, Guard and Gear Reducer, But **NOT** the Motor)



CAD FILE NO.: 16573

PUMP MODEL	RPM @ 1750	RPM @ 1150	REDUCER ①		FRAME	MTG.FT. OPTION REQ.	DRIVE ASSY NO.	
			MAX HP @ 1750	MAX HP @ 1150				
GMS D	875	575	2.00:1	5.65	3.73	56C	STD	90253-510
				11.70	7.72	143TC/145TC	STD	90253-516
				11.70	7.72	182C/184C	80F	90253-519
				13.01	8.59	182TC/184TC	80F	90253-526
	580	383	3.00:1	3.76	2.48	56C	STD	90253-530
				8.10	5.35	143TC/145TC	STD	90253-533
				8.10	5.35	182C/184C	80F	90253-539
				10.62	7.01	182TC/184TC	80F	90253-546
	440	288	4.00:1	2.82	1.86	56C	STD	90253-550
				5.90	3.89	143TC/145TC	STD	90253-553
				5.90	3.89	182C/184C	80F	90253-562
				7.24	4.78	182TC/184TC	80F	90253-566
	350	230	5.00:1	2.26	1.49	56C	STD	90253-570
				5.20	3.43	143TC/145TC	STD	90253-573
				5.20	3.43	182C/182C	80F	90253-582
				5.98	3.95	182TC/184TC	80F	90253-586
GMS G	875	575	2.00:1	5.65	3.73	56C	STD	90253-610
				11.70	7.72	143TC/145TC	STD	90253-616
				11.70	7.72	182C/184C	80F	90253-624
				13.01	8.59	182TC/184TC	80F	90253-626
				13.01	8.59	213TC/213TC	80J	90253-628
	580	383	3.00:1	3.76	2.48	56C	STD	90253-630
				8.10	5.35	143TC/145TC	STD	90253-639
				8.10	5.35	182C/184C	80F	90223-639
				10.62	7.01	182TC/184TC	80F	90253-646
				10.62	7.01	213TC/215TC	80J	90253-648
	440	288	4.00:1	2.82	1.86	56C	STD	90253-660
				5.90	3.89	143TC/145TC	STD	90253-663
				5.90	3.89	182C/184C	80F	90253-672
				7.24	4.78	182TC/184TC	80F	90253-675
	350	230	5.00:1	7.24	4.78	213TC	80J	90253-677
				2.26	1.49	56C	STD	90253-690
5.20				3.43	143TC/145TC	STD	90253-693	
5.20				3.43	182C/184C	80F	90253-702	
350	230	5.00:1	5.89	3.95	182TC/184TC	80F	90253-705	
			5.89	3.95	213TC	80J	90253-707	
			5.89	3.95	213TC	80J	90253-707	

(CONT'D)

① Listed reducer horsepower rated for Standard Service (8-10 hrs/day). For Light Service (3-5 hrs/day) multiply maximum rated horsepower by 1.1. For Heavy Service (16-24 hrs/day) multiply maximum rated horsepower by 0.9.

NOTE: CONSULT FACTORY FOR OPTIONS NOT SHOWN.



# GMS

## GRR REDUCER C-FLANGE FLEX DRIVE OPTIONS

(Drive Assembly Number Includes Base, Coupling, Guard and Gear Reducer, But **NOT** the Motor)

PUMP MODEL	RPM @ 1750	RPM @ 1150	REDUCER <sup>①</sup>		FRAME	MTG.FT. OPTION REQ.	DRIVE ASSY NO.	
			MAX HP @ 1750	MAX HP @ 1150				
GMS J	875	575	2.00:1	13.01	8.59	182TC/184TC	80F	90253-722
				13.01	8.59	213TC/215TC	STD	90253-724
				36.29	23.95	254TC/256TC	80P	90253-728
				36.29	23.95	284TC/286TC	80P	90253-732
	580	383	3.00:1	10.62	7.01	182TC/184TC	80F	90253-735
				10.62	7.01	213TC/215TC	80J	90253-741
	550	365	3.15:1	25.76	17.00	254TC/256TC	80P	90253-743
				25.76	17.00	284TC	80P	90253-746
				42.96	28.35	286TC	80P	90253-747
	440	288	4.00:1	7.24	4.78	182TC/184TC	80F	90253-750
				7.24	4.78	213TC	80J	90253-754
	350	230	5.00:1	5.98	3.95	182TC/184TC	80F	90253-767
				5.98	3.95	213TC	STD	90253-769
				16.01	10.57	215TC	80P	90253-774
				30.49	20.12	254TC/256TC	80J	90253-778
	GMS N	875	575	2.00:1	13.01	8.59	213TC/215TC	STD
36.29					23.95	254TC/256TC	80P	90253-801
36.29					23.95	284TC/286TC	80P	90253-805
580		383	3.00:1	10.62	7.01	213TC/215TC	STD	90253-814
				25.76	17.00	254TC/256TC	80P	90253-819
550		365	3.15:1	42.96	28.35	284TC/286TC	80P	90253-820
				7.24	4.78	213TC	STD	90253-827
350		230	5.00:1	5.98	3.95	213TC	STD	90253-842
				16.01	10.57	215TC	80P	90253-845
				30.49	20.12	254TC/256TC	80P	90253-847
GMS R	640	417	2.76:1	80.20	52.93	324TC	STD	90253-874
				80.20	52.93	364TC	STD	90253-878
	555	365	3.15:1	10.10	6.66	213TC/215TC	STD	90253-881
				25.76	17.00	254TC/256TC	STD	90253-886
				42.96	28.35	284TC/286TC	STD	90253-891
	520	340	3.38:1	66.20	43.69	324TC	STD	90253-896
				66.20	43.69	326TC	STD	90253-898
	440	288	4.00:1	9.42	6.22	184TC	STD	90253-901
				20.00	13.20	213TC/215TC	STD	90253-904
				38.16	25.18	254TC/256TC	STD	90253-909
				38.16	25.18	284TC	STD	90253-913
	420	278	4.13:1	40.40	26.40	286TC	STD	90253-916
				54.40	35.90	324TC	STD	90253-918
	350	230	5.00:1	6.10	4.03	184TC	STD	90253-921
				16.01	10.57	213TC/215TC	STD	90253-924
30.49				20.12	254TC/256TC	STD	90253-929	
30.49				20.12	284TC/286TC	STD	90253-933	

① Listed reducer horsepower rated for Standard Service (8-10 hrs/day). For Light Service (3-5 hrs/day) multiply maximum rated horsepower by 1.1. For Heavy Service (16-24 hrs/day) multiply maximum rated horsepower by 0.9.

NOTE: CONSULT FACTORY FOR OPTIONS NOT SHOWN.

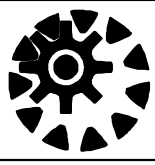

# PERFORMANCE CURVES

## SPEED VS. CAPACITY/HORSEPOWER

# GH

Hydraulic Size

SEC. 500

Page 50

January 2010

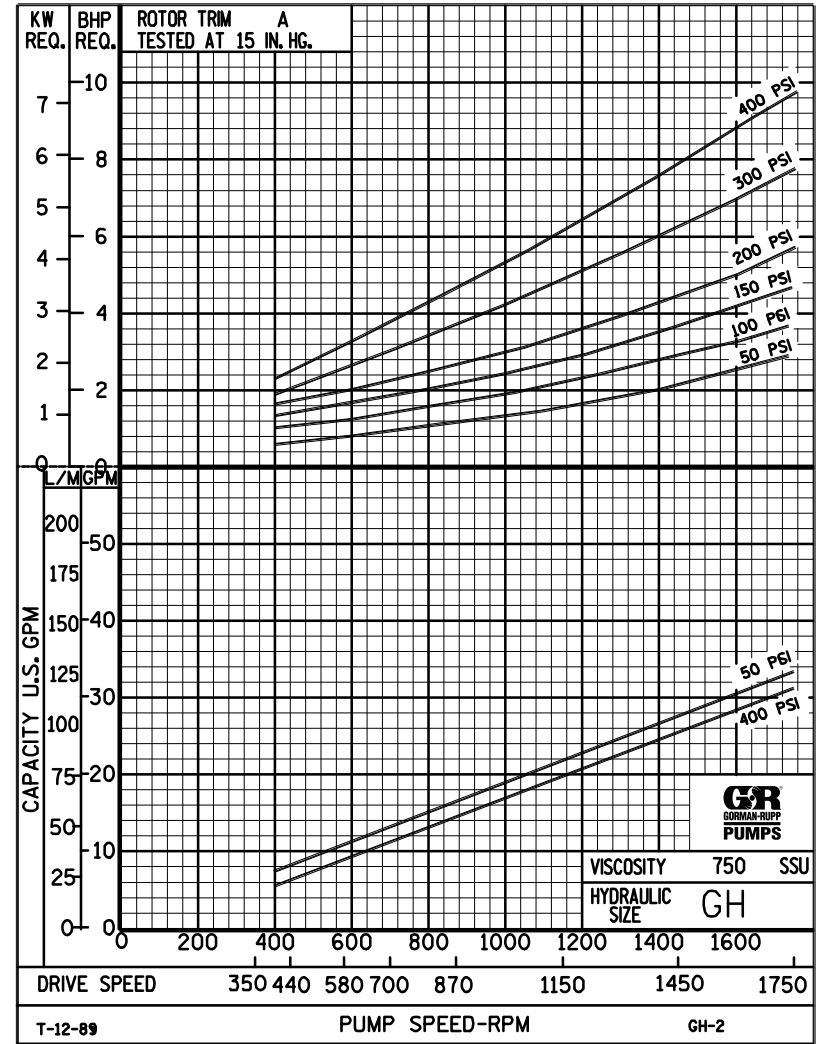
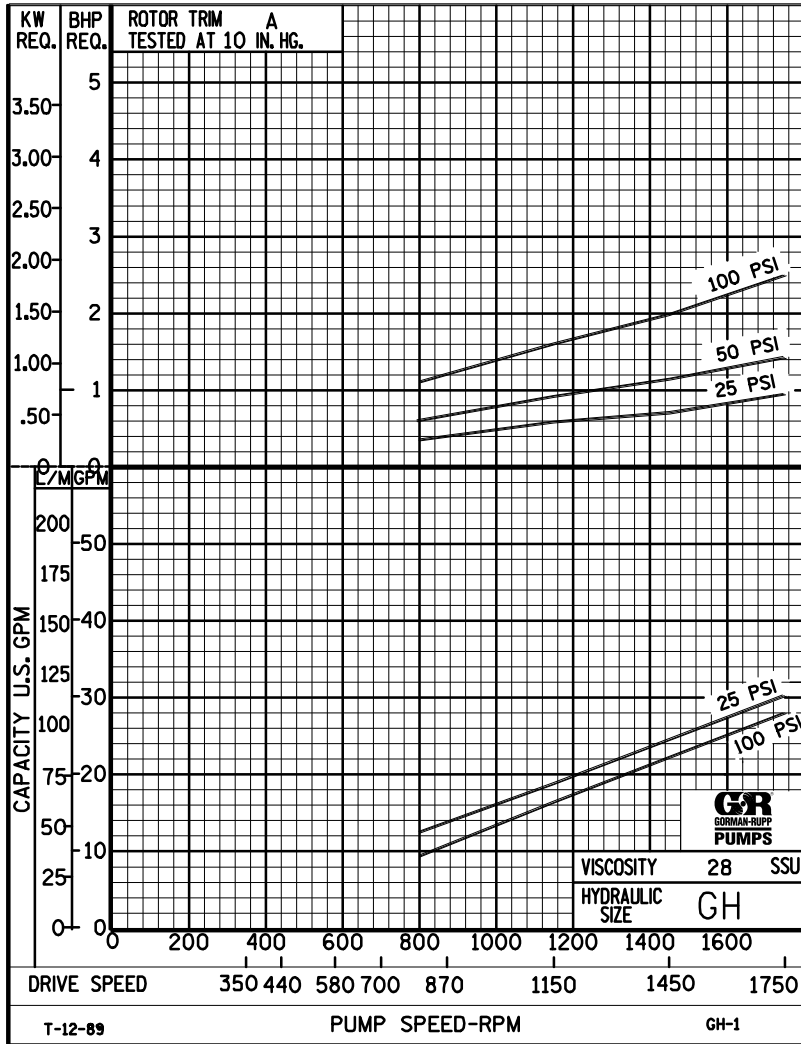

**THE GORMAN-RUPP COMPANY • MANSFIELD, OHIO**  
 GORMAN-RUPP OF CANADA LIMITED • ST. THOMAS, ONTARIO, CANADA

Printed in U.S.A.



# PERFORMANCE CURVES

## SPEED VS. CAPACITY/HORSEPOWER

# GH

Hydraulic Size

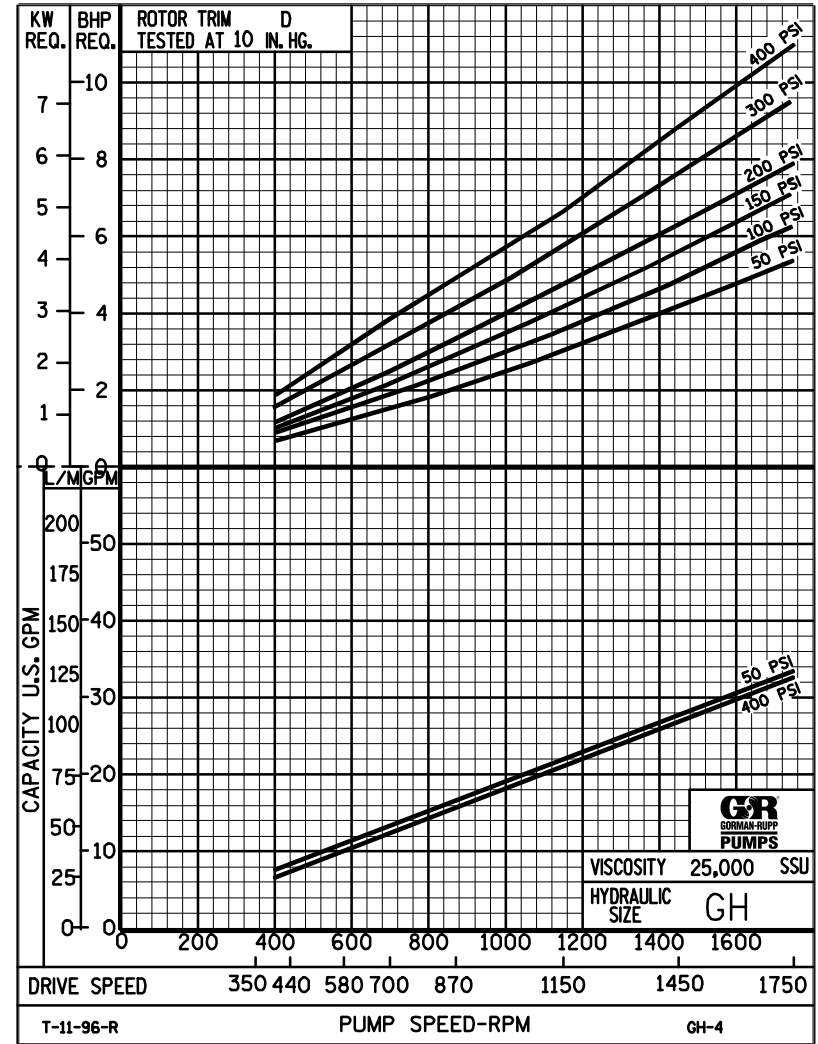
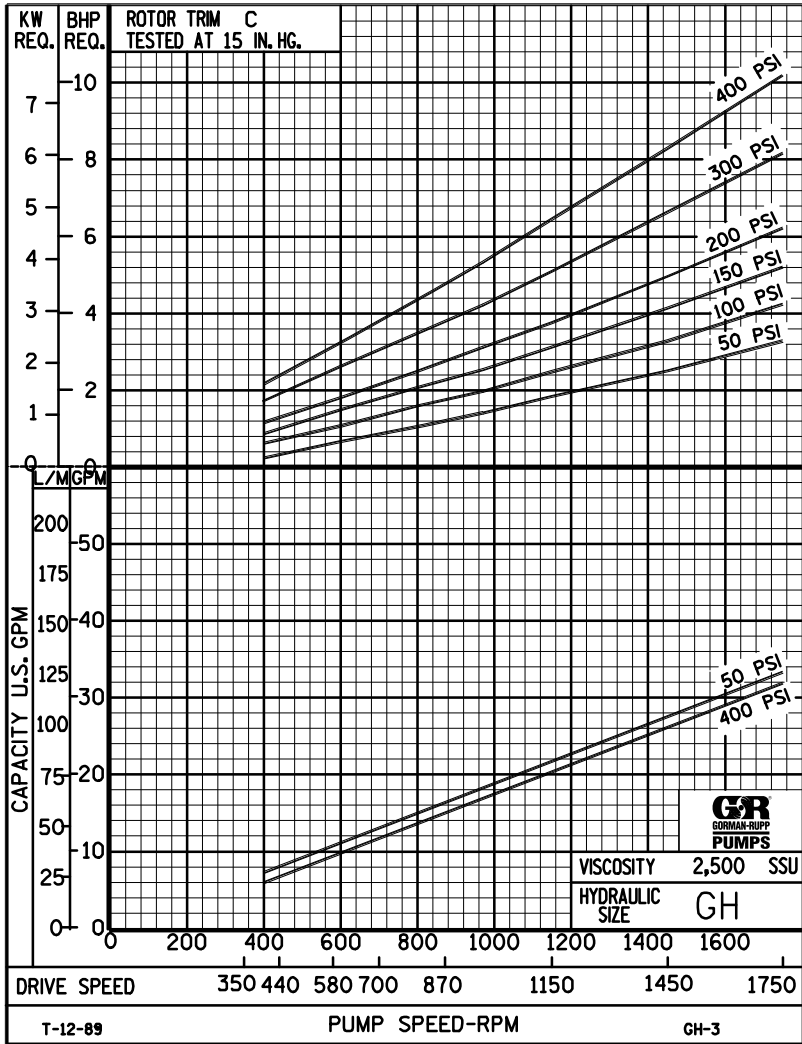

THE GORMAN-RUPP COMPANY • MANSFIELD, OHIO  
 GORMAN-RUPP OF CANADA LIMITED • ST. THOMAS, ONTARIO, CANADA

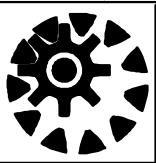

# GH

## PUMP HYDRAULIC SIZE CHART

SEC. 500

Page 52  
January 2010

**31 GPM  
1750 RPM**

NOMINAL		ROTOR TRIM	VISCOSITY (SSU)	N.I.P.R. (PSIA)	FRICTION PIPE LOSS (PSI/FT) <small>(Based on Sch 40 Steel Pipe)</small>					FULL BYPASS RELIEF VALVE PRESSURE (PSI)					CAPACITY (GPM) / H.P. REQUIRED										
					PIPE DIAMETER					CRACKING PRESS. (PSI)					DIFFERENTIAL PRESSURE (PSI)										
CAP. GPM	SPEED RPM				3/4"	1"	1 1/4"	1 1/2"	2"	LOW PRES R/V					MEDIUM DUTY AND HEAVY DUTY				HEAVY DUTY ONLY						
										50	75	100	150	200	25	50	75	100	150	200	300	400			
31	1750	STD	28	4.2	.01	.01	.01	.01	.01	68	97	126			30	29	28	28							
			32		.61	.19	.05	.03	.01							.95	1.4	2.0	2.5						
			38	4.2	.78	.25	.07	.03	.01	68	97	126	176			31	30	29	29	28					
			50		.93	.30	.08	.04	.01							1.2	1.8	2.5	2.7	3.9					
			70	4.2	1.02	.35	.09	.05	.02	70	99	128	176	230		32	31	31	30	29	29				
			100		1.22	.39	.11	.05	.02							1.4	2.0	2.6	3.0	4.2	5.0				
			150	4.2	1.35	.44	.12	.06	.02	72	101	130	176	232		32	32	32	31	31	30	29	28		
			200		1.58	.52	.13	.07	.03							1.6	2.3	2.8	3.3	4.4	5.2	7.3	9.3		
			300	4.2	1.80	.61	.16	.08	.03	72	101	130	177	234		33	32	32	32	31	31	30	30		
			500		1.98	.75	.25	.14	.05							1.9	2.8	3.1	3.7	4.8	5.6	7.5	9.6		
		750	4.2	2.97	1.13	.38	.21	.08	74	102	132	177	235		33	33	33	33	32	32	31	30			
		1,000		3.96	1.51	.51	.27	.10							2.0	3.0	3.5	3.8	5.0	5.8	7.7	9.8			
				"C"	2,000	5.5	7.91	3.01	1.00	.54	.20	76	103	133	178	238	33	33	33	33	33	32	32	31	
					3,500		13.9	5.27	1.76	.95	.35							2.2	3.3	4.0	4.5	5.5	6.5	8.4	11
					5,000	6.3	20.0	7.53	2.52	1.36	.50	80	105	137	180	240	33	33	33	33	33	32	32	31	
					7,500		29.7	11.3	3.77	2.04	.75							2.9	4.4	5.0	5.4	6.4	7.3	9.2	11.0
					10,000	7.1	39.6	15.1	5.03	2.71	1.00	84	109	140	182	242	33	33	33	33	33	32	32	32	
					15,000		59.3	22.6	7.54	4.07	1.50							3.7	5.5	6.0	6.6	7.6	8.5	10	12
					20,000	7.8	79.1	30.1	10.1	5.43	2.00	88	113	144	184	244	33	33	33	33	33	32	32	32	
					25,000		98.9	37.6	12.6	6.78	2.50							4.7	6.8	7.4	7.9	8.9	9.9	12	14
		50,000																							
		75,000																							
		100,000																							
		150,000																							
		200,000																							
		250,000																							

(NOTE) For speeds not shown on the pump hydraulic charts, consult factory.

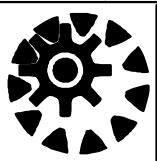

# GH

## PUMP HYDRAULIC SIZE CHART

SEC. 500

Page 53

January 2010

**20 GPM  
1150 RPM**

NOMINAL		ROTOR TRIM	VISCOSITY (SSU)	N.I.P.R. (PSIA)	FRICTION PIPE LOSS (PSI/FT) <small>(Based on Sch 40 Steel Pipe)</small>					FULL BYPASS RELIEF VALVE PRESSURE (PSI)					CAPACITY (GPM) / H.P. REQUIRED																		
CAP. GPM	SPEED RPM				PIPE DIAMETER					CRACKING PRESS. (PSI)					DIFFERENTIAL PRESSURE (PSI)																		
		3/4"	1"	1 1/4"	1 1/2"	2"	LOW PRES R/V					MEDIUM DUTY AND HEAVY DUTY				HEAVY DUTY ONLY																	
							50	75	100	150	200	25	50	75	100	150	200	300	400														
20	1150	STD	28	2.3	.01	.01	.01	.01	.01	63	89	114			18	18	17	16															
			32		.28	.09	.03	.01	.01								.58	.91	1.3	1.6													
			38	2.3	.36	.12	.03	.02	.01	63	89	114	164			19	19	18	17	17													
			50		.44	.14	.04	.02	.01								.66	1.1	1.4	1.7	2.3												
			70	2.3	.49	.15	.04	.02	.01	64	90	116	166	228		20	20	19	18	18	17												
			100		.58	.19	.05	.02	.01								.83	1.2	1.6	1.9	2.6	2.9											
			150	2.3	.64	.21	.06	.03	.01	64	90	116	166	228		21	20	20	19	18	18	17	16										
			200		.68	.25	.08	.04	.02								.91	1.3	1.7	2.0	2.8	3.3	4.5	5.9									
			300	2.3	.78	.30	.10	.06	.02	65	91	120	167	230		21	21	21	20	20	19	19	18										
			500		1.28	.49	.16	.09	.03								1.0	1.5	1.8	2.1	2.9	3.5	4.9	6.0									
			750	2.3	1.92	.73	.24	.13	.05	65	91	120	167	230		22	21	21	21	21	21	20	20										
			1,000		2.55	.97	.33	.18	.07								1.2	1.7	2.2	2.4	3.0	3.6	4.9	6.2									
				"C"	2,000	3.1	5.10	1.94	.65	.35	.13	66	92	121	168	230	22	21	21	21	21	21	21	21	21	21	20						
					3,500		8.93	3.40	1.14	.61	.23							1.3	1.9	2.2	2.5	3.1	3.8	5.1	6.4								
					5,000	3.6	12.8	4.86	1.62	.88	.32	73	95	123	170	230	22	22	21	21	21	21	21	21	21	21	21	21					
					7,500		19.1	7.29	2.43	1.31	.49							1.7	2.5	2.7	3.0	3.7	4.4	5.6	6.9								
					10,000	4.1	25.5	9.71	3.24	1.75	.65	76	97	126	170	230	22	22	22	21	21	21	21	21	21	21	21	21					
					15,000		38.3	14.6	4.86	2.63	.97							2.6	3.0	3.4	3.7	4.4	5.1	6.3	7.6								
				20,000	4.6	51.0	19.4	6.49	3.50	1.29	79	101	128	172	230	22	22	22	21	21	21	21	21	21	21	21	21						
				25,000		63.8	24.3	8.11	4.38	1.61							3.5	3.7	4.1	4.4	5.1	5.7	7.0	8.3									
				50,000	7.3	128	48.6	16.2	8.75	3.22	84	107	132	178	235	22	22	22	21	21	21	21	21	21	21	21	21						
				75,000		191	72.8	24.3	13.1	4.83							5.4	5.7	6.3	6.8	7.4	8.2	9.6	11									
				100,000																													
				150,000																													
				200,000																													
		250,000																															

(NOTE) For speeds not shown on the pump hydraulic charts, consult factory.



# GH

## PUMP HYDRAULIC SIZE CHART

SEC. 500

Page 54

January 2010

**15 GPM  
870 RPM**

NOMINAL		ROTOR TRIM	VISCOSITY (SSU)	N.I.P.R. (PSIA)	FRICTION PIPE LOSS (PSI/FT) <small>(Based on Sch 40 Steel Pipe)</small>					FULL BYPASS RELIEF VALVE PRESSURE (PSI)					CAPACITY (GPM) / H.P. REQUIRED													
					PIPE DIAMETER					CRACKING PRESS. (PSI)					DIFFERENTIAL PRESSURE (PSI)													
CAP. GPM	SPEED RPM				3/4"	1"	1 1/4"	1 1/2"	2"	LOW PRES R/V					HI PRES R/V					MEDIUM DUTY AND HEAVY DUTY				HEAVY DUTY ONLY				
										50	75	100	150	200	50	75	100	150	200	25	50	75	100	150	200	300	400	25
15	870	STD	28	1.6	.01	.01	.01	.01	.01	59	86	111				14	13	12	11									
			32		.17	.06	.02	.01	.01							.42	.68	.98	1.2									
			38	1.6	.22	.07	.02	.01	.01	59	86	111	161			14	14	13	12	12								
			50		.27	.09	.03	.01	.01							.48	.74	1.0	1.3	1.8								
			70	1.6	.30	.10	.03	.01	.01	60	87	113	163	215		15	14	14	13	13	13							
			100		.36	.12	.03	.02	.01							.67	.89	1.1	1.4	1.8	2.3							
			150	1.6	.41	.14	.05	.02	.01	60	87	113	163	217		16	15	15	14	14	14	13	12					
			200		.46	.18	.06	.03	.01							.74	.96	1.2	1.5	1.9	2.4	3.4	4.3					
			300	1.6	.58	.22	.08	.04	.02	60	87	115	165	219		16	16	15	15	15	15	14	13					
			500		.96	.37	.12	.07	.03							.82	1.0	1.3	1.5	2.0	2.5	3.5	4.5					
		750	1.6	1.44	.55	.18	.10	.04	60	87	115	165	222		16	16	16	16	16	15	15	14						
		1,000		1.92	.73	.25	.13	.05							.89	1.1	1.4	1.6	2.1	2.6	3.6	4.6						
		2,000	2.2	3.83	1.46	.49	.26	.10	62	90	115	165	222		16	16	16	16	16	16	15	15						
		3,500		6.70	2.55	.85	.46	.17							1.1	1.3	1.5	1.8	2.3	2.8	3.8	4.8						
		5,000	2.7	9.57	3.64	1.22	.66	.24	65	92	117	167	224		16	16	16	16	16	16	16	15						
		7,500		14.4	5.46	1.83	.99	.36							1.4	1.6	1.9	2.2	2.7	3.2	4.0	5.1						
		10,000	3.1	19.1	7.29	2.43	1.31	.49	68	94	119	169	224		16	16	16	16	16	16	16	16						
		15,000		28.7	10.9	3.65	1.97	.73							1.9	2.1	2.4	2.7	3.2	3.7	4.6	5.6						
		20,000	3.5	38.3	14.6	4.87	2.63	.97	72	97	122	172	224		16	16	16	16	16	16	16	16						
		25,000		47.8	18.2	6.08	3.28	1.21							2.4	2.6	2.9	3.1	3.7	4.2	5.1	6.1						
50,000	5.8	95.7	36.4	12.2	6.56	2.42	77	102	127	177	229		16	16	16	16	16	16	16	16								
75,000		144	54.6	18.3	9.85	3.63							3.8	4.0	4.3	4.5	5.0	5.5	6.5	7.5								
100,000	8.4	191	72.8	24.3	13.1	4.83	85	110	135	185	239		16	16	16	16	16	16	16	16								
150,000		-	-	-	-	-							4.6	4.8	5.1	5.4	5.8	6.4	7.3	8.3								
200,000																												
250,000																												

(NOTE) For speeds not shown on the pump hydraulic charts, consult factory.



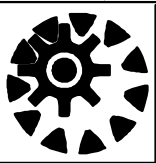

# GH

## PUMP HYDRAULIC SIZE CHART

SEC. 500

Page 55

January 2010

### 10 GPM 580 RPM

NOMINAL		ROTOR TRIM	VISCOSITY (SSU)	N.I.P.R. (PSIA)	FRICTION PIPE LOSS (PSI/FT) <small>(Based on Sch 40 Steel Pipe)</small>					FULL BYPASS RELIEF VALVE PRESSURE (PSI)					CAPACITY (GPM) / H.P. REQUIRED																		
CAP. GPM	SPEED RPM				PIPE DIAMETER					CRACKING PRESS. (PSI)					DIFFERENTIAL PRESSURE (PSI)																		
					3/4"	1"	1 1/4"	1 1/2"	2"	LOW PRES R/V		HI PRES R/V			25	50	75	100	150	200	300	400											
													MEDIUM DUTY AND HEAVY DUTY				HEAVY DUTY ONLY																
10	580	STD	28	1.2	.01	.01	.01	.01	.01	56	81	106			9	8.5	8	7.5															
			32		.08	.03	.01	.01	.01							.25	.41	.59	.73														
			38	1.2	.11	.04	.01	.01	.01	56	81	106	157			9.5	9	8.5	8	7.5													
			50		.13	.04	.01	.01	.01							.29	.45	.63	.80	1.1													
			70	1.2	.14	.05	.02	.01	.01	56	81	107	158	209			10	9.5	9.5	9	8.5	8.5											
			100		.14	.05	.02	.01	.01								.40	.54	.69	.84	1.1	1.4											
			150	1.2	.17	.07	.03	.02	.01	57	82	108	158	211			10	10	10	9.5	9.5	9	9	9	8								
			200		.30	.12	.04	.02	.01								.45	.58	.73	.88	1.2	1.4	2.0	2.6									
			300	1.2	.39	.15	.05	.02	.01	57	82	109	159	212			11	10	10	10	10	9.5	9.5	9									
			500		.64	.24	.08	.05	.02								.49	.62	.77	.92	1.2	1.5	2.1	2.7									
			750	1.2	.96	.36	.12	.07	.03	57	82	111	161	214			11	11	10	10	10	10	10	9.5									
			1,000		1.28	.49	.16	.09	.03								.54	.66	.82	.97	1.3	1.6	2.2	2.8									
		"C"	2,000	1.7	2.55	.97	.33	.18	.07	58	85	112	162	214		11	11	11	10	10	10	10	10	10									
			3,500		4.46	1.70	.57	.31	.12							.64	.76	.91	1.1	1.4	1.7	2.3	2.9										
			5,000	2.1	6.38	2.43	.81	.44	.16	60	85	112	162	214		11	11	11	11	10	10	10	10	10									
			7,500		9.57	3.64	1.22	.66	.24							.82	.97	1.1	1.3	1.6	1.9	2.4	3.0										
			10,000	2.5	12.8	4.86	1.62	.88	.32	63	88	114	166	216		11	11	11	11	10	10	10	10	10									
			15,000		19.2	7.29	2.43	1.31	.49							1.1	1.3	1.4	1.6	1.9	2.2	2.8	3.4										
			20,000	2.9	25.5	9.71	3.24	1.75	.65	66	91	116	168	218		11	11	11	11	10	10	10	10	10									
			25,000		31.9	12.2	4.05	2.19	.81							1.4	1.5	1.7	1.9	2.2	2.5	3.2	3.9										
			50,000	4.8	63.8	24.3	8.11	4.38	1.61	69	94	122	172	224		11	11	11	11	10	10	10	10	10									
			75,000		95.7	36.4	12.2	6.56	2.42							2.0	2.2	2.4	2.5	2.9	3.2	3.9	4.6										
			100,000	7.1	128	48.6	16.2	8.75	3.22	73	98	126	176	230		11	11	11	11	10	10	10	10	10									
			150,000		191	72.9	24.3	13.1	4.83							2.5	2.8	3.0	3.2	3.5	3.9	4.5	5.2										
200,000																																	
250,000																																	

(NOTE) For speeds not shown on the pump hydraulic charts, consult factory.