

# GHC SERIES HEAVY DUTY COMPACT ROTARY GEAR PUMP

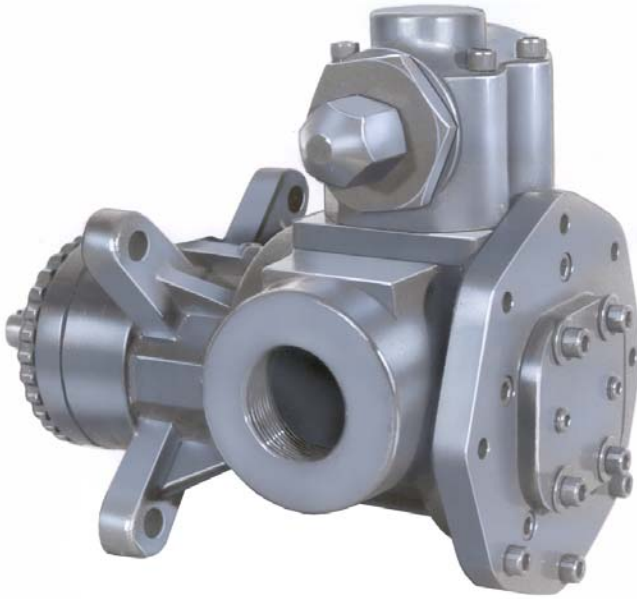

**SHOWN AS FLANGE MOUNT**

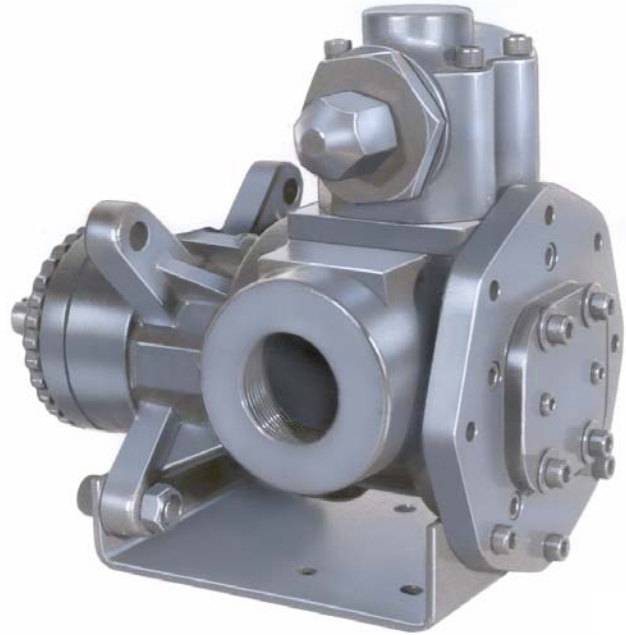

**SHOWN WITH FOOT BRACKET**

The GHC iron series is designed for applications in the operating ranges noted below. These units are available with head jackets for temperature control, carbon graphite bushings for low viscosity liquids, silicon carbide bushings for wear resistance, and numerous shaft seal options described on the following pages.

These units may be foot mounted or, by using a motor adaptor, direct connected to NEMA "C" flange motors.

This heavy duty series provides superior rotor shaft support and an integral, maintenance-free radial/ thrust bearing for reduced deflection and wear.

### FEATURES

*300 PSI CAPABILITY  
 BALL BEARING THRUST CONTROL  
 ROTOR END CLEARANCE EXTERNALLY  
 ADJUSTABLE  
 HIGH STRENGTH, COMPUTER  
 PROFILED GEARING FOR QUIET  
 OPERATION  
 C-FLANGE MOTOR ADAPTATION  
 MULTIPLE PORT POSITIONS*

### OPERATING RANGE

CAPACITY (GPM): (3 TO 107)  
 [LPM]: [11 TO 405]

PRESSURE (PSI) : [0 TO 300]  
 [BAR]: [0 TO 21]

VISCOSITY (SSU): (28 TO 250,000)  
 [cSt]: [1 TO 55,000]

TEMPERATURE (F) : (-60° TO 350°)  
 [C] : [-51° TO 177°]

### APPLICATIONS

USE WITH ANY CLEAN LIQUID  
 COMPATIBLE WITH CAST  
 IRON

- ★ BOOSTER SERVICE
- ★ CIRCULATING
- ★ FILTERING
- ★ LUBRICATING
- ★ TRANSFERRING
- ★ LOW PRESSURE  
 FLUID POWER

EXTER- IOR	ROTOR & IDLER	HOUSING PORTS	BUSHINGS	IDLER PIN	SHAFT	SHAFT SEALING		ROTATION	INTERNAL RELIEF VALVE	
						MECH. SEAL ●	LIPSEAL ■		MATERIAL	SETTING
CAST IRON	HIGH STRENGTH IRON	180° TAPPED	BRONZE	HARDENED STEEL	STEEL	VITON	BUNA-N	C.W.	DUCTILE IRON	75 PSI [5 BAR]

## Standard Models

**G H C 1 DC 3 - B**  
 | | | | | | | | | | | |  
 GEAR DUTY DESIGN PORT SIZE HYDRAULIC SEAL STYLE  
 SIZE SIZE

MODEL NUMBER	NOM. CAPACITY - SPEED				MAXIMUM				SHIPPING DATA	
	MAXIMUM		ALTERNATIVE		DIFFERENTIAL PRESSURE-PSI [BAR]			TEMP.	Weight	Volume
	GPM [LPM]	RPM 60 Hz [50 HZ]	GPM [LPM]	RPM <sup>(3)</sup> 60 Hz [50 HZ]	BELOW 38 SSU [4 cSt]	38 TO 100 SSU [21 cSt]	100 TO 250,000 SSU [55,000 cSt]	°F [°C]		
<b>GHC 1DC 3-B</b> ● ① <b>GHC 1DC 4-B</b> ■ ①	9 [28]		6 [19]						29 [13,2]	0.6
<b>GHC 1DE 3-B</b> ● ① <b>GHC 1DE 4-B</b> ■ ①	11 [35]		7 [22]						30 [13,6]	0.6
<b>GHC 1-1/2 GC 3-B</b> ● <b>GHC 1-1/2 GC 4-B</b> ■	16 [50]		10 [32]						58 [26,4]	2.9
<b>GHC 2 GC 3-B</b> ● <b>GHC 2 GC 4-B</b> ■										
<b>GHC 1-1/2 GF 3-B</b> ● <b>GHC 1-1/2 GF 4-B</b> ■	23 [73]	1750 [1460]	15 [47]	1150 [960]	100 [7]	150 [10]		350 [177]	58 [26,4]	2.9
<b>GHC 2 GF 3-B</b> ● <b>GHC 2 GF 4-B</b> ■									58 [26,4]	2.9
<b>GHC 1-1/2 GH 3-B</b> ● <b>GHC 1-1/2 GH 4-B</b> ■	31 [98]		20 [63]					225 [107]	58 [26,4]	2.9
<b>GHC 2 GH 3-B</b> ● <b>GHC 2 GH 4-B</b> ■									58 [26,4]	2.9
<b>GHC 1-1/2 GJ 3-B</b> ● ② <b>GHC 1-1/2 GJ 4-B</b> ■ ②	38 [120]		25 [79]						58 [26,4]	2.9
<b>GHC 2 GJ 3-B</b> ● ② <b>GHC 2 GJ 4-B</b> ■ ②									58 [26,4]	2.9
<b>GHC 2 JG 3-B</b> ● <b>GHC 2 JG 4-B</b> ■	40 [126]	1150 [960]	30 [95]	870 [725]					128 [58,2]	5.3
<b>GHC 2-1/2 JG 3-B</b> ● <b>GHC 2-1/2 JG 4-B</b> ■									128 [58,2]	5.3
<b>GHC 3 JG 3-B</b> ● <b>GHC 3 JG 4-B</b> ■									128 [58,2]	5.3

STANDARD MODELS  
CONTINUED

● MECHANICAL SEAL      ■ LIPSEAL

**NOTE:** RECOMMENDED PORT SIZES ARE SHOWN IN **BOLDFACE**. EXAMPLE: **GHC 1 DC 3-B**

- ① 3450 [2875] RPM PERMISSIBLE TO 1,000 SSU [220 cSt] AND 100 PSI [7 BAR]
- ② PUMP LIMITED TO 200 PSI MAXIMUM PRESSURE.
- ③ MAXIMUM SPEED FOR AMMONIA MODELS.

**THE GORMAN-RUPP COMPANY • MANSFIELD, OHIO**  
GORMAN-RUPP OF CANADA LIMITED • ST. THOMAS, ONTARIO, CANADA

MODEL NUMBER	NOM. CAPACITY - SPEED				MAXIMUM				SHIPPING DATA	
	MAXIMUM		ALTERNATIVE		DIFFERENTIAL PRESSURE-PSI [BAR]			TEMP.	Weight	Volume
	GPM [LPM]	RPM 60 Hz [50 HZ]	GPM [LPM]	RPM <sup>②</sup> 60 Hz [50 Hz]	BELOW 38 SSU [4 cST]	38 TO 100 SSU [21 cST]	100 TO 250,000 SSU [55,000 cSt]	°F [°C]		
GHC 2 JJ 3-B ● GHC 2 JJ 4-B ■	56 [177]	1150 [960]	42 [133]	870 [725]	100 [7]	150 [10]	300 [21]	350 [177]	132	5.3
GHC 2-1/2 JJ 3-B ● GHC 2-1/2 JJ 4-B ■									[60]	
GHC 3 JJ 3-B ● GHC 3 JJ 4-B ■									[60]	5.3
GHC 2 JL 3-B ● GHC 2 JL 4-B ■	77 [243]	1150 [960]	58 [183]	870 [725]	100 [7]	150 [10]	300 [21]	350 [177]	132	5.3
GHC 2-1/2 JL 3-B ● GHC 2-1/2 JL 4-B ■									[60]	
GHC 3 JL 3-B ● GHC 3 JL 4-B ■									[60]	5.3
GHC 2 JP 3-B ● ① GHC 2 JP 4-B ■ ①	107 [338]	1150 [960]	81 [256]	870 [725]	100 [7]	150 [10]	200 [14]	225 [107]	132	5.3
GHC 2-1/2 JP 3-B ● ① GHC 2-1/2 JP 4-B ■ ①									[60]	
GHC 3 JP 3-B ● ① GHC 3 JP 4-B ■ ①									[60]	5.3

NOTE: RECOMMENDED PORT SIZES ARE SHOWN IN **BOLDFACE**. EXAMPLE: **GHC 1 DC 3-B**

- ① PUMP LIMITED TO 200 PSI MAXIMUM PRESSURE.
- ② MAXIMUM SPEED FOR AMMONIA MODELS.

<b>APPLICATION RECOMMENDATIONS:</b>		
<b>APPLICATION</b>	<b>OPTIONS REQUIRED (Select One from Each Row)</b>	<b>OPERATING LIMITATIONS</b>
AMMONIA	25G, 25H, 25R, 25S, 25T 40N 60K 70E 90A	PRESSURE: 200 PSI MAX. 2/3 RATED SPEED. 4 FEET NPSHr
LP GAS	25G OR 25H 40F OR 40N 70D OR 70E	PRESSURE: 200 PSI MAX. 3 FEET NPSHr

NOTE: PROPER PUMP APPLICATION REQUIRES CONSIDERATION OF ADDITIONAL FACTORS. PLEASE REVIEW APPLICATION GUIDE IN SECTION 500 OR CONSULT THE FACTORY.

# Basic Pump Dimensions

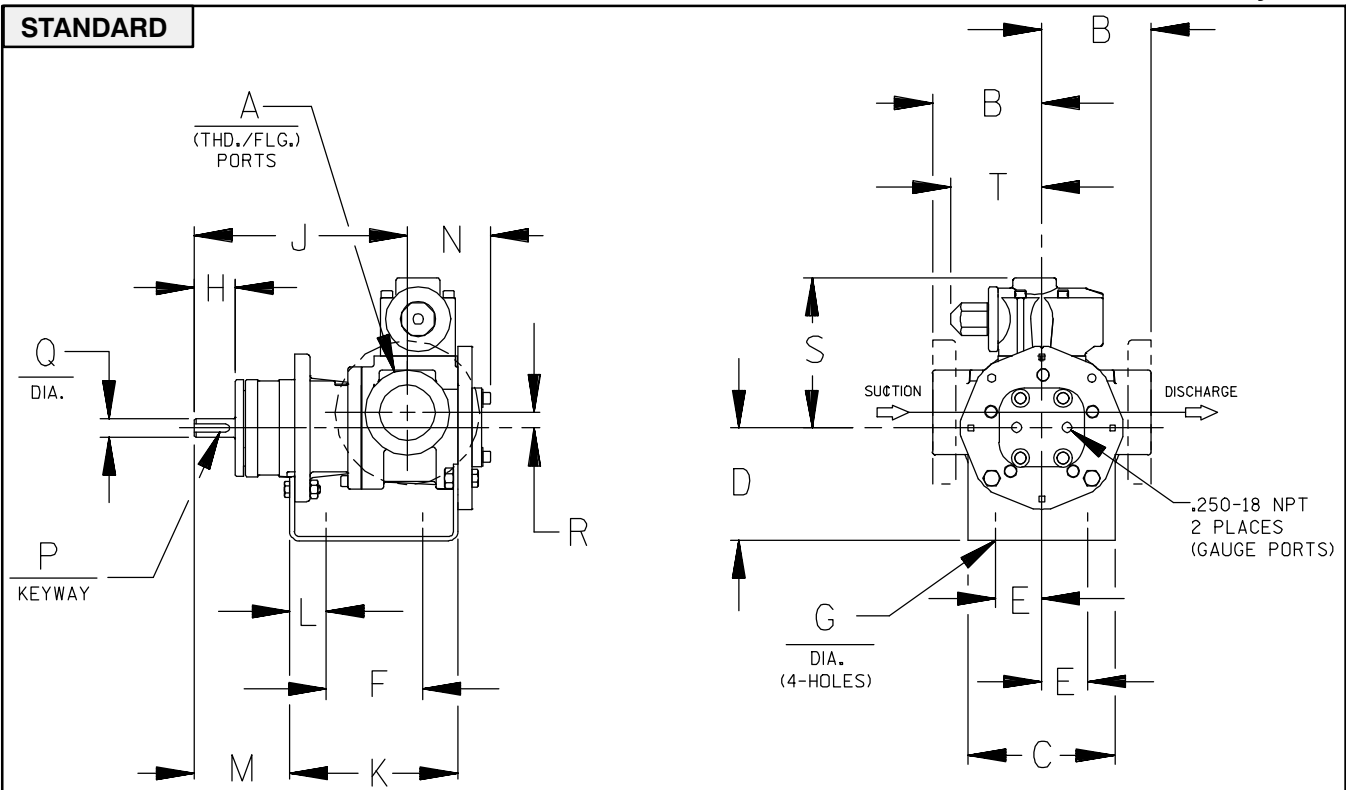

CAD FILE NO.: 16458

MODEL NUMBERS	PUMP DIMENSIONS - INCHES [MILLIMETERS]																	
	A	B	C	D	E	F	G	H	J	K	L	M	N	P	Q	R	S	T
GHC D	1"	2.50 [64] †	4.00 [102]	3.50* [89]	1.62 [41]	3.12 [79]	.41 [10]	1.16 [30]	6.19 [157]	5.04 [128]	.76 [19]	2.62 [66]	2.74 [70]	.12 [3]	.50 [13]	.62 [16]	5.19 [132]	3.58 [91]
		2.75* [70]		4.50 [114]										5.25 [133]				
GHC G	1-1/2"	3.50 [89] †	5.88 [149]	3.50* [89]	1.62 [41]	4.00 [102]	.41 [10]	1.62	8.50 [216]	6.71 [170]	1.06 [27]	3.82 [97]	3.35 [85]	.19 [5]	.75 [19]	.62 [16]	6.00 [152]	3.62 [92]
		3.75* [95]		4.50 [114]										5.25 [133]				
GHC J	2-1/2"	4.50 [114] †	6.88 [175]	4.50 [114]	2.88 [73]	4.25 [108]	.44 [11]	2.50 [64]	12.12 [308]	9.75 [248]	1.75 [44]	5.50 [140]	4.66 [118]	.25 [6]	1.00 [25]	1.12 [28]	9.06 [230]	6.75 [171]
		5.00* [127]		5.25* [133]										2.00 [51]				
		6.00 [152] †		6.25 [159]										7.00 [178]				
	3"	6.31 † [160]		8.00 [203]														

\* STANDARD DIMENSION

† 90° HOUSING

‡ PORTS ARE COMPATIBLE WITH 125\* OR 250\* ANSICAST IRON FLANGES. ALL OTHER PORTS ARE TAPPED NPT FOR ANSIPIPE. OPTIONAL (DIN) FLANGES OR TAPPED (BSP) PORTS AVAILABLE FOR EXPORT MARKET.

Continued —

# Basic Pump Dimensions

**OPTION 80Z (SHOWN LESS FOOT)**

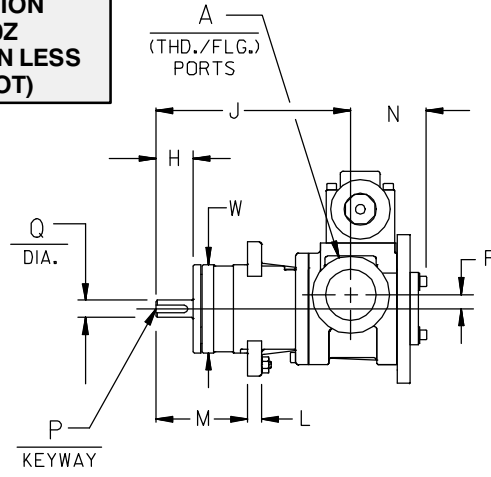
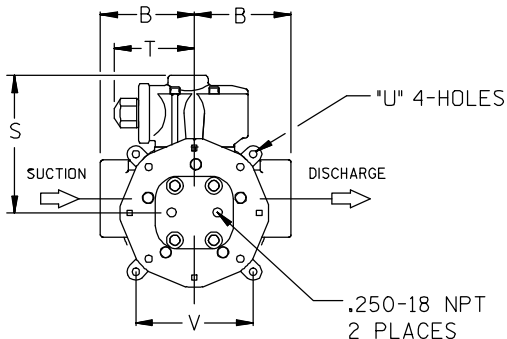
CAD FILE NO.: 16458C

MODEL NUMBERS	PUMP DIMENSIONS - INCHES [MILLIMETERS]														
	A	B	H	J	L	M	N	P	Q	R	S	T	U	V	W
GHC D	1"	2.50 [64] †	1.16 [30]	6.19 [157]	.44 [11]	2.80 [71]	2.74 [70]	.12 [3] x .75 [19]	.50 [13]	.62 [16]	5.19 [132]	3.58 [91]	.41 [10]	3.00 [76]	2.85 [72]
		2.75* [70]													
		3.19 † [81]													
		4.00 † [102]													
GHC G	1-1/2"	3.50 [89] †	1.62 [41]	8.50 [216]	.62 [16]	4.00 [102]	3.35 [85]	.19 [5] x 1.25 [32]	.75 [19]	.62 [16]	6.00 [152]	3.62 [92]	.53 [13]	4.75 [121]	3.85 [98]
		3.75* [95]													
	2"	4.00 [102] †													
GHC J	2-1/2"	4.50 [114] †	2.50 [64]	12.12 [308]	.62 [16]	5.75 [146]	4.66 [118]	.25 [6] x 2.00 [51]	1.00 [25]	1.12 [28]	9.06 [230]	6.75 [171]	.53 [13]	4.75 [121]	4.85 [123]
		5.00* [127]													
	6.00 † [152]														
	3"	6.31 † [160]													

\* STANDARD DIMENSION

† PORTS ARE COMPATIBLE WITH 125# OR 250# ANSICAST IRON FLANGES. ALL OTHER PORTS ARE TAPPED NPT FOR ANSIPIPE, OPTIONAL (DIN) FLANGES OR TAPPED (BSP) PORTS AVAILABLE FOR EXPORT MARKET.

† 90° HOUSING



# GHC

## DIRECT FLEX DRIVE OPTION DIMENSIONS

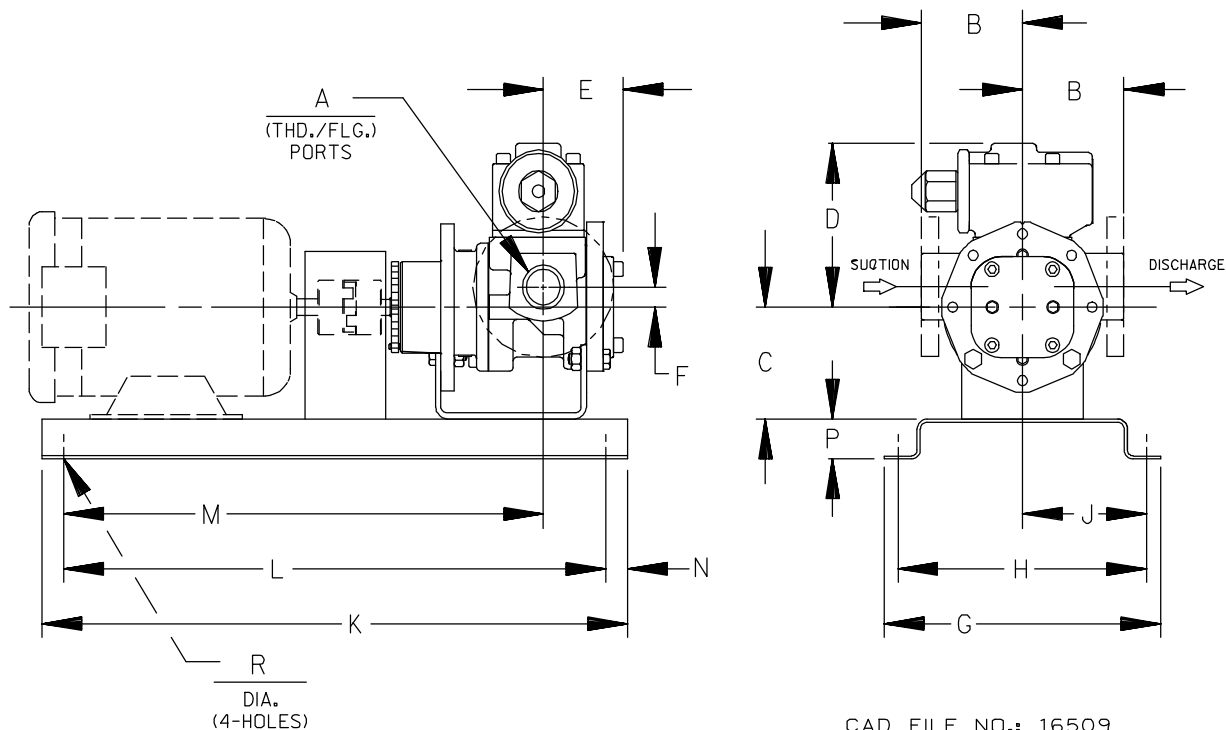

CAD FILE NO.: 16509

PUMP MODEL	PUMP DIMENSIONS - INCHES[MILLIMETERS]																
	A	MOTOR FRAME	B	C	D	E	F	G	H	J	K	L	M	N	P	R	
GHC D	1'	56/56 H	2.50 † [64]	3.50 * [89]				10.14 [258]	8.88 [226]	4.44 [113]	25.25 [641]	19.25 [489]	20.50 [521]	3.00 [76]	2.00 [51]		
		143T/145T	2.75 * [70]														
		182T/184T	3.19 † [81]	4.50 [114]	5.19 [132]	2.73 [68]	.62 [16]		17.50 [445]	15.50 [394]	7.75 [197]	33.50 [851]	23.50 [597]	26.87 [682]	5.00 [127]	4.00 [102]	.56 [14]
		213T/215T	4.00 † [102]	5.25 [133]													
GHC G	1- 1/2"	56/56H	3.50 † [89]	3.50 * [89]				10.14 [258]	8.88 [226]	4.44 [113]	25.25 [641]	19.25 [489]	20.38 [518]	3.00 [76]	2.00 [51]		
		182T/184T	3.75 * [95]	4.50 [114]	6.00 [152]	3.35 [85]	.62 [16]		17.50 [445]	15.50 [394]	7.75 [197]	33.50 [851]	23.50 [597]	26.75 [679]	5.00 [127]	4.00 [102]	.56 [14]
	2"	213T/215T	4.00 † [102]	5.25 [133]													
		254T/256T	6.25 [159]														
GHC J	2"	182T/184T	4.50 † [114]	4.50 [114]													
		213T/215T	5.25 * [133]	6.25 [159]	9.06 [230]	4.66 [118]	1.12 [28]	21.00 [533]	19.00 [483]	9.50 [241]	45.50 [1156]	35.50 [902]	38.38 [975]	5.00 [127]	4.00 [102]	.69 [18]	
	2- 1/2"	254T/256T	5.00 * [127]	6.25 [159]													
		284T/286T	6.00 † [152]	7.00 [178]													
3"	324T/326T	6.31 † [160]	8.00 † [203]														

\* STANDARD DIMENSION

† 90° HOUSING

┆ PORTS ARE COMPATIBLE WITH 125\* OR 250\* ANSICAST IRON FLANGES. ALL OTHER PORTS ARE TAPPED NPT FOR ANSI PIPE. OPTIONAL (DIN) FLANGES OR TAPPED (BSP) PORTS AVAILABLE FOR EXPORT MARKET.

**NOTE: CONSULT FACTORY FOR;**  
 1. HORSEPOWERS & FRAMES NOT SHOWN  
 2. DRIP PAN BASES

REFERENCE: PUMP FOOT BRACKET OPTIONS		
MOTOR FRAME	CENTER HEIGHT	PUMP OPTION
56, 143T, 145T	3.50"	80C (STD. "D/G")
182, 182T, 184, 184T	4.50"	80F
213, 213T, 215, 215T	5.25"	80J (STD. "J")
254T, 254U, 256T, 256U	6.25"	80P
284T, 284U, 286T, 286U	7.00"	80S

# GHC

## DIRECT FLEX DRIVE OPTIONS

(Drive Assembly Number Includes Base, Coupling & Guard, But **NOT** the Motor)

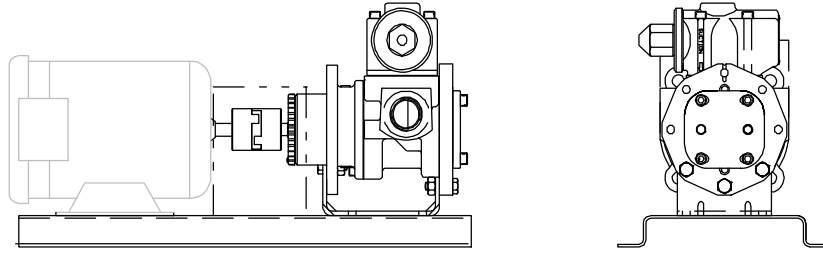

PUMP MODEL NUMBER	60 Hz RPM	50 Hz RPM	FRAME	MTG. FT. OPTION REQ.	DRIVE ASSY NO.
GHC D	3450 1750 1150 850	2900 1450 950 700	56/56H	STD	90351-086
			143T/145T	STD	90351-052
			184	80F	90351-089
			182T/184T	80F	90351-090
			213T/215T	80J	90351-094
GHC G	1750 1150 850	1450 950 700	56/56H	STD	90351-156
			143T/145T	STD	90351-162
			182T/184T	80F	90351-168
			213T/215T	80J	90351-206
			213T/215T	80J	90351-172
			254T	80P	90351-180
GHC J	1150 850	950 700	182T/184T	80F	90351-260
			213T/215T	STD	90351-268
			254T/256T	80P	90351-276
			284T/286T	80S	90351-280

**NOTE: CONSULT FACTORY FOR;  
HORSEPOWERS & FRAMES NOT SHOWN  
DRIP PAN BASES**





# GHC

## DIRECT FLEX C-FLANGE DRIVE OPTION DIMENSIONS

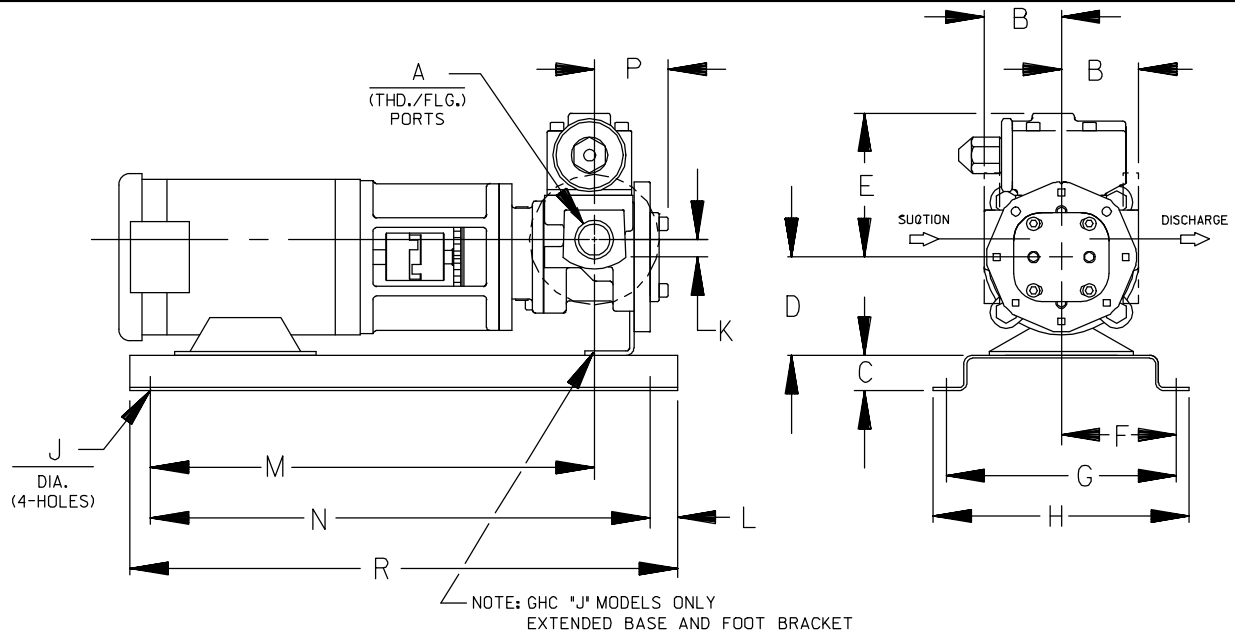

CAD FILE NO.: 16652

PUMP MODEL	PUMP DIMENSIONS - INCHES[MILLIMETERS]															
	A	MOTOR FRAME	B	C	D	E	F	G	H	J	K	L	M	N	P	R
GHC D	1"	56C	2.50 † [64]	2.00 [51]	3.50 [89]	5.19 [132]	6.25 [159]	12.50 [318]	14.50 [368]	.56 [14]	.62 [16]	2.00 [51]	17.24 [438]	12.75 [324]	2.73 [69]	16.75 [425]
		143TC/145TC	2.75 * [70]										17.55 [446]			
		182C/184C	3.12 † [79]										18.80 [478]			
GHC G	1- 1/2"	56C	3.50 † [89]	2.00 [51]	4.50 [114]	6.00 [152]	6.25 [159]	12.50 [318]	14.50 [368]	.56 [14]	.62 [16]	2.00 [51]	19.42 [493]	12.75 [324]	3.35 [85]	16.75 [425]
		143TC/145TC	3.75 * [95]										19.73 [501]			
	2"	182C/184C	4.00 † [102]	5.25 [133]	21.86 [555]											
		213TC/215TC	5.00 * [127]													
GHC J	2"	182TC/184TC	4.50 † [114]	4.00 [102]	5.25 [133]	9.06 [230]	9.50 [241]	19.00 [483]	21.00 [533]	.69 [18]	1.12 [28]	5.00 [127]	26.86 [682]	35.50 [902]	4.66 [118]	45.50 [1156]
		213TC/215TC	5.00 * [127]										27.75 [705]			
	2- 1/2"	213TC/215TC	6.00 † [152]	6.25 [159]	33.74 [857]											
		254TC/256TC	6.31 † [160]													

\* STANDARD DIMENSION

† PORTS ARE COMPATIBLE WITH 125# OR 250# ANSICAST IRON FLANGES. ALL OTHER PORTS ARE TAPPED NPT FOR ANSIPIPE. OPTIONAL (DIN) FLANGES OR TAPPED (BSP) PORTS AVAILABLE FOR EXPORT MARKET.

† 90° HOUSING

**NOTE: CONSULT FACTORY FOR;**  
 1. HORSEPOWERS & FRAMES NOT SHOWN  
 2. DRIP PAN BASES

REFERENCE: PUMP FOOT BRACKET OPTIONS		
HYDRAULIC SIZE	MOTOR FRAME	PUMP OPTION
D	56C, 143TC, 145TC, 182C, 184C	80Y
G	56C, 143TC, 145TC, 182C, 184C	80Y
J	213TC, 215TC 254TC, 256TC	80X 80W

## DIRECT FLEX C-FLANGE DRIVE OPTIONS

(Drive Assembly Number Includes Base & Coupling, But **NOT** the Motor)

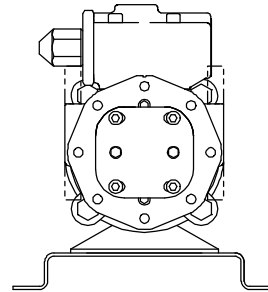
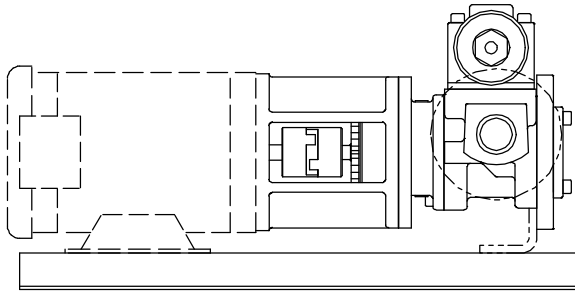

PUMP MODEL NUMBER	60Hz RPM	FRAME	MTG. FT. OPTION REQ.	DRIVE ASSY NO.
GHC D	3450	56C	80Y	90351-540
	1750	143TC	80Y	90351-541
	1150	145TC	80Y	90351-544
	850	184C	80Y	90351-590
GHC G	1750 1150 850	56C	80Y	90351-656
		143TC	80Y	90351-659
		145TC	80Y	90351-660
		184C	80Y	90351-668
		182TC	80X	90351-672
		184TC	80X	90351-674
GHC J	1150 850	213TC	80X	90351-764
		215TC	80X	90351-768
		254TC	80W	90351-772
		256TC	80W	90351-776
		184TC	80X	90351-814

**NOTE: CONSULT FACTORY FOR;  
HORSEPOWERS & FRAMES NOT SHOWN  
DRIP PAN BASES**



# GHC

## GRR REDUCER C-FLANGE FLEX DRIVE OPTION DIMENSIONS

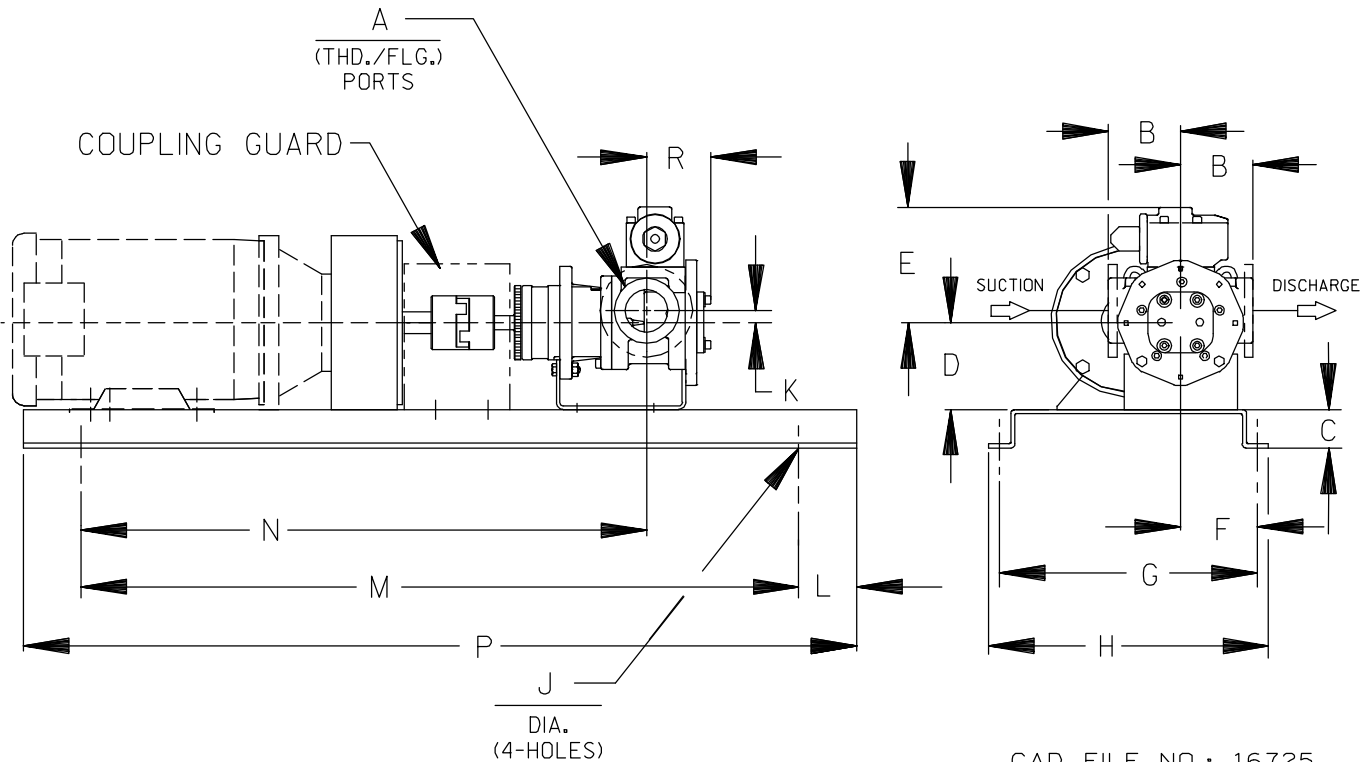

PUMP MODEL	PUMP DIMENSIONS - INCHES[MILLIMETERS]															
	A	MOTOR FRAME	B	C	D	E	F	G	H	J	K	L	M	N	P	R
GHC D	1"	56C	2.50 † [64]	2.00 [51]	3.50 [89] *	5.19 [132]	4.41 [112]	13.00 [330]	15.00 [381]	.56 [14]	.62 [16]	3.00 [76]	25.50 [648]	20.35 [517]	31.50 [800]	2.66 [68]
		143TC/145TC	2.75 * [70]													
		182TC/184TC	3.19 † [81]													
		213TC/215TC	4.00 † [82]													
GHC G	1- 1/2"	56C	3.50 † [89]	2.00 [51]	3.50 [89] *	6.00 [152]	4.41 [112]	13.00 [330]	15.00 [381]	.56 [14]	.62 [16]	3.00 [76]	25.50 [648]	22.66 [576]	31.50 [800]	3.27 [83]
		143TC/145TC	3.75 * [95]													
	2"	182TC/184TC	4.00 † [102]													
		213TC/215TC	4.00 † [102]													
GHC J	2"	182TC/184TC	4.50 † [114]	2.00 [51]	4.50 [114]	9.06 [230]	5.50 [140]	14.63 [372]	16.63 [422]	.69 [18]	1.12 [28]	3.00 [76]	37.25 [946]	32.42 [823]	43.25 [1099]	4.56 [116]
	2- 1/2"	213TC/215TC	5.00 * [127]													
		3"	213TC/215TC													
	3"		213TC/215TC													

\* STANDARD DIMENSION

† PORTS ARE COMPATIBLE WITH 125# OR 250# ANSICAST IRON FLANGES. ALL OTHER PORTS ARE TAPPED NPT FOR ANSIPIPE. OPTIONAL (DIN) FLANGES OR TAPPED (BSP) PORTS AVAILABLE FOR EXPORT MARKET.

† 90° HOUSING

## GRR REDUCER C-FLANGE FLEX DRIVE OPTIONS

(Drive Assy Number Includes Base, Coupling, Guard & Gear Reducer, But **NOT** the Motor)

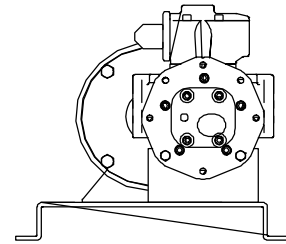
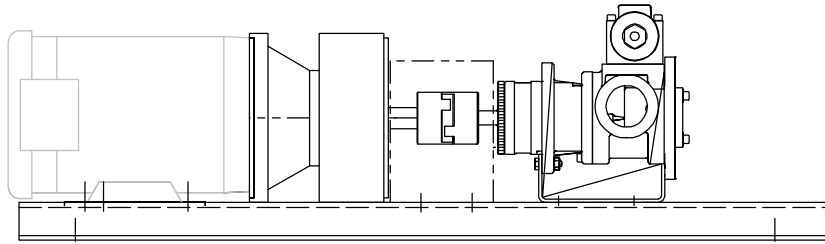

PUMP MODEL	RPM @ 1750	RPM @ 1150	REDUCER <sup>①</sup>		FRAME	MTG.FT. OPTION REQ.	DRIVE ASSY NO.	
			RATIO	MAX HP @ 1750				MAX HP @ 1150
<b>GHC D</b>	875	575	2.00:1	6.00	3.96	56C	STD	90353-510
				6.00	3.96	143TC/145TC	STD	90353-516
				6.00	3.96	182C/184C	80F	90353-519
				20.00	13.2	182TC/184TC	80F	90353-526
	580	383	3.00:1	4.21	2.78	56C	STD	90353-530
				8.10	5.35	143TC/145TC	STD	90353-536
				8.10	5.35	182C/184C	80F	90353-539
	440	288	4.00:1	12.98	8.57	182TC/184TC	80F	90353-546
				3.63	2.39	56C	STD	90353-550
				5.90	3.89	143TC/145TC	STD	90353-556
				5.90	3.89	182C/184C	80F	90353-564
	350	230	5.00:1	11.35	7.49	56C	STD	90353-568
				3.00	1.98	143TC/145TC	STD	90353-570
				3.00	1.98	182C/182C	80F	90353-573
				5.90	3.89	182TC/184TC	80F	90353-579
				10.07	6.65	182TC/184TC	80F	90353-586

(CONT'D)

<sup>①</sup> Listed reducer horsepower rated for Standard Service (8-10 hrs/day). For Light Service (3-5 hrs/day) multiply maximum rated horsepower by 1.1. For Heavy Service (16-24 hrs/day) multiply maximum rated horsepower by 0.9.

**NOTE: CONSULT FACTORY FOR;  
HORSEPOWERS & FRAMES NOT SHOWN  
DRIP PAN BASES**



# GHC

**SEC. 540**

**PAGE 22**

**January 2010**

## GRR REDUCER C-FLANGE FLEX DRIVE OPTIONS

(Drive Assy Number Includes Base, Coupling, Guard & Gear Reducer, But **NOT** the Motor)

PUMP MODEL	RPM @ 1750	RPM @ 1150	REDUCER ①		FRAME	MTG.FT. OPTION REQ.	DRIVE ASSY NO.	
			RATIO	MAX HP @ 1750				MAX HP @ 1150
<b>GHC G</b>	875	575	2.00:1	5.65	3.73	56C	STD	90353-610
				11.70	7.72	143TC/145TC	STD	90353-619
				11.70	7.72	182C/184C	80F	90353-622
				13.01	8.59	182TC/184TC	80F	90353-625
				13.01	8.59	213TC/215TC	80J	90353-627
	580	383	3.00:1	3.76	2.48	56C	STD	90353-630
				8.10	5.35	143TC/145TC	STD	90353-633
				8.10	5.35	182C/184C	80F	90353-642
				10.62	7.01	182TC/184TC	80F	90353-646
				10.62	7.01	213TC/215TC	80J	90353-648
	440	288	4.00:1	2.82	1.86	56C	STD	90353-660
				5.90	3.89	143TC/145TC	STD	90353-663
				5.90	3.89	182C/184C	80F	90353-672
				7.24	4.78	182TC/184TC	80F	90353-675
				7.24	4.78	213TC	80J	90353-677
	350	230	5.00:1	2.26	1.49	56C	STD	90353-690
				5.20	3.43	143TC/145TC	STD	90353-699
				5.20	3.43	182C/184C	80F	90353-702
				5.98	3.95	182TC/184TC	80F	90353-706
				5.98	3.95	213TC	80J	90353-708
<b>GHC J</b>	875	575	2.00:1	13.01	8.59	182TC/184TC	80F	90353-720
				13.01	8.59	213TC/215TC	80J	90353-724
				36.29	23.95	254TC/256TC	80P	90353-728
				36.29	23.95	284TC/286TC	80P	90353-732
	580	383	3.00:1	10.62	7.01	182TC/184TC	80F	90353-735
				10.62	7.01	213TC/215TC	80J	90353-739
	555	365	3.15:1	25.76	17.00	254TC/256TC	80P	90353-743
				25.76	17.00	284TC	80P	90353-746
				42.96	28.35	286TC	80P	90353-747
	440	288	4.00:1	7.24	4.78	182TC/184TC	80F	90353-750
				7.24	4.78	213TC	80J	90353-754
	350	230	5.00:1	5.98	3.95	182TC/184TC	80F	90353-765
				5.98	3.95	213TC	80J	90353-769
				16.01	10.57	215TC	80P	90353-774
				16.01	10.57	254TC	80P	90353-778
			30.49	20.12	356TC	80P	90353-780	

① Listed reducer horsepower rated for Standard Service (8-10 hrs/day). For Light Service (3-5 hrs/day) multiply maximum rated horsepower by 1.1. For Heavy Service (16-24 hrs/day) multiply maximum rated horsepower by 0.9.

**NOTE: CONSULT FACTORY FOR;  
HORSEPOWERS & FRAMES NOT SHOWN  
DRIP PAN BASES**

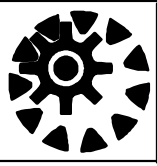

# PERFORMANCE CURVES

## SPEED VS. CAPACITY/HORSEPOWER

# JG

Hydraulic Size

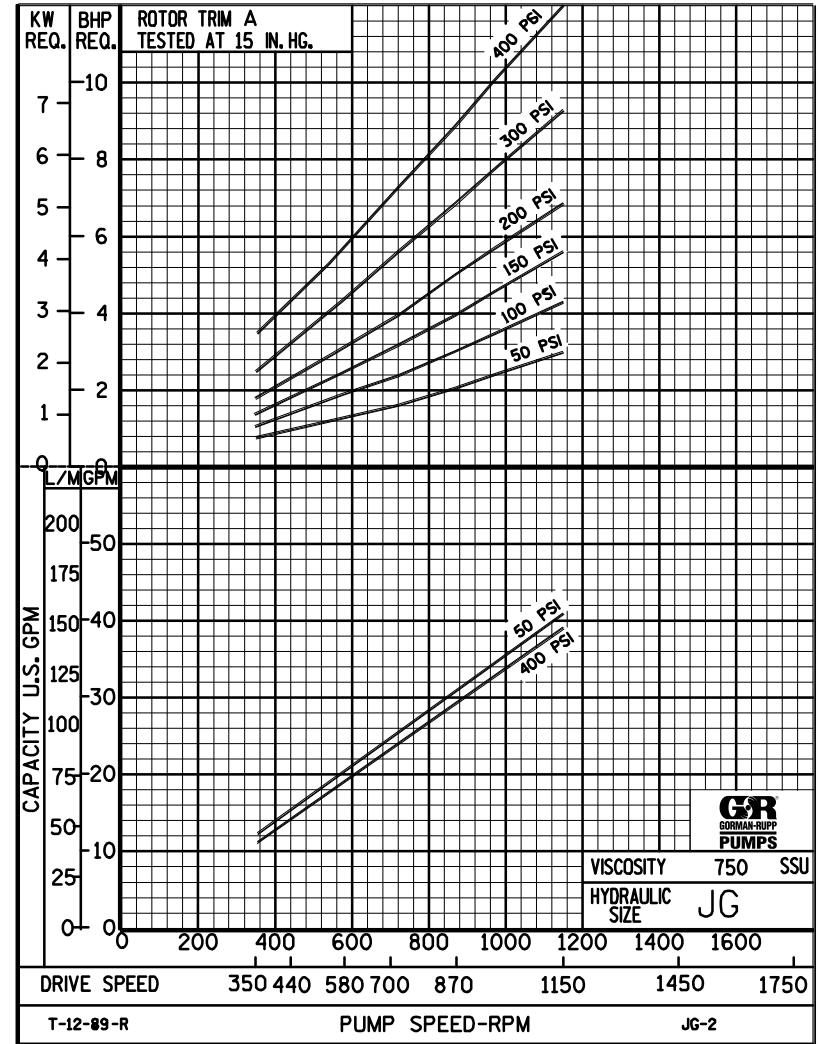
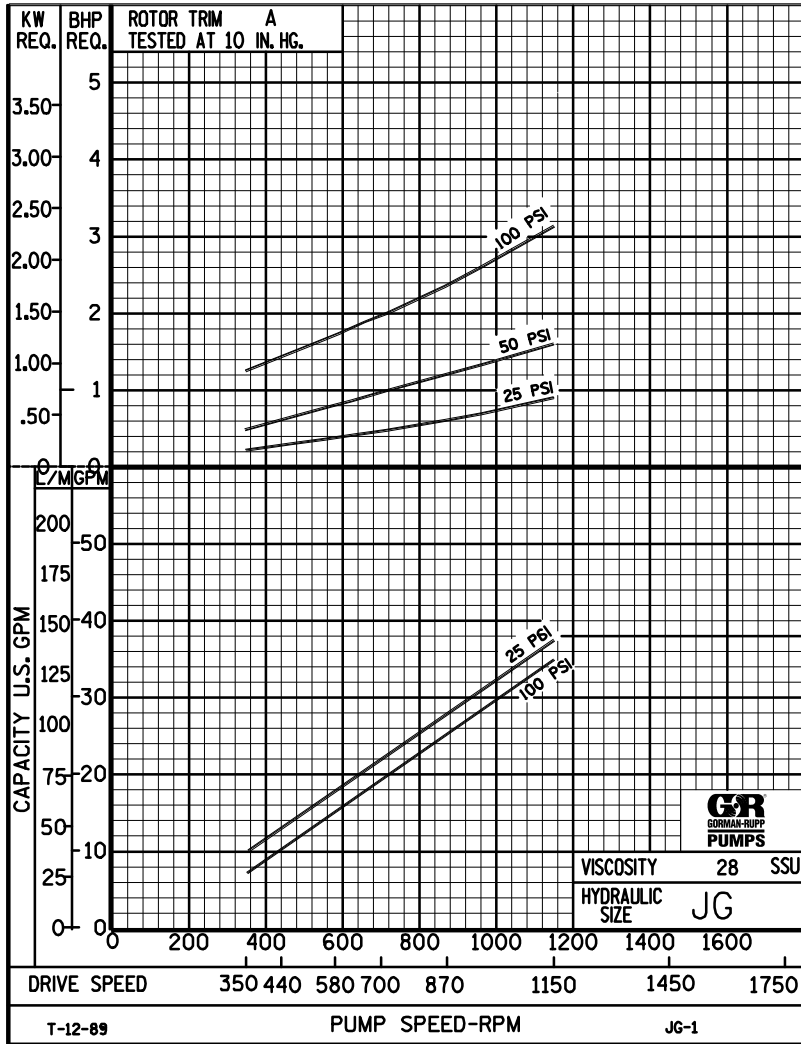

**THE GORMAN-RUPP COMPANY • MANSFIELD, OHIO**  
 GORMAN-RUPP OF CANADA LIMITED • ST. THOMAS, ONTARIO, CANADA

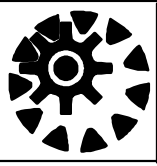

# PERFORMANCE CURVES

## SPEED VS. CAPACITY/HORSEPOWER

**JG** Hydraulic Size

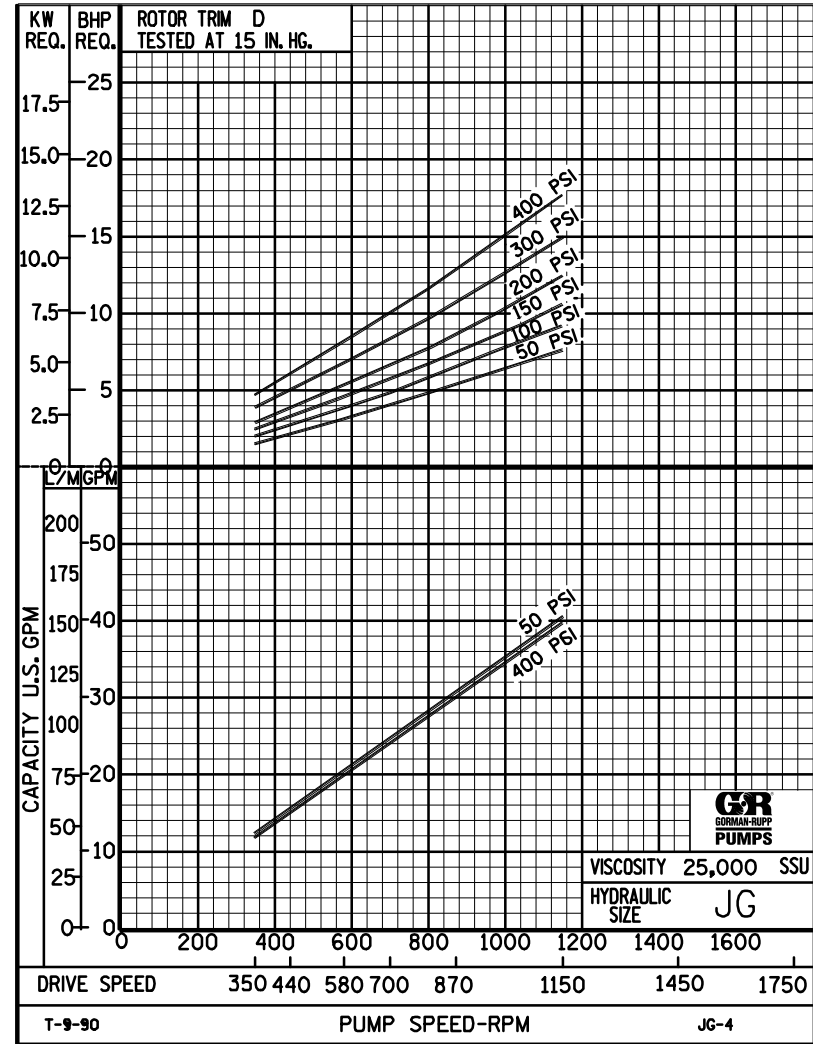
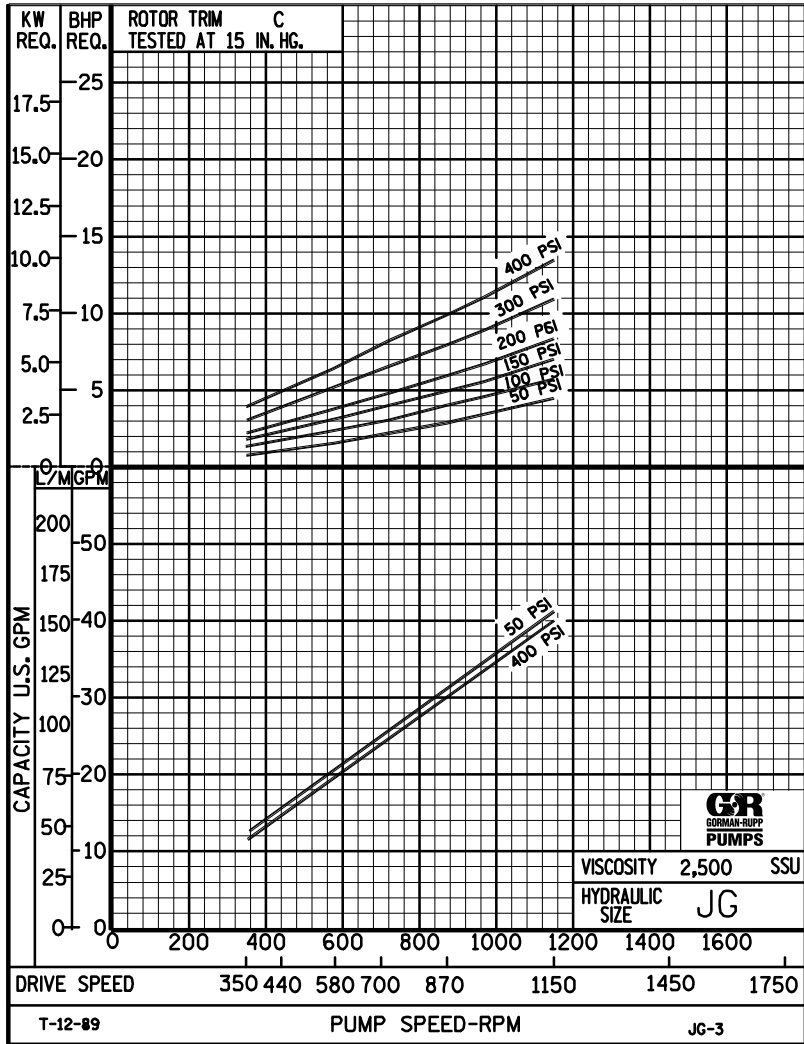

THE GORMAN-RUPP COMPANY • MANSFIELD, OHIO  
 GORMAN-RUPP OF CANADA LIMITED • ST. THOMAS, ONTARIO, CANADA







# JG

## PUMP HYDRAULIC SIZE CHART

SEC. 500

Page 65  
January 2010

**30 GPM**  
**870 RPM**

NOMINAL		ROTOR TRIM	VISCOSITY (SSU)	N.I.P.R. (PSIA)	FRICTION PIPE LOSS (PSI/FT) <small>(Based on Sch 40 Steel Pipe)</small>					FULL BYPASS RELIEF VALVE PRESSURE (PSI)					CAPACITY (GPM) / H.P. REQUIRED													
CAP. GPM	SPEED RPM				PIPE DIAMETER					CRACKING PRESS. (PSI)					DIFFERENTIAL PRESSURE (PSI)													
					1½"	2"	2½"	3"	4"	LOW PRES R/V			HI PRES R/V		MEDIUM DUTY AND HEAVY DUTY				HEAVY DUTY ONLY									
30	870	STD	28	2.5	.01	.01	.01	.01	.01	55	81	112			27	27	26	25										
			32		.02	.01	.01	.01	.01						.63	1.2	1.7	2.4										
			38	2.5	.03	.01	.01	.01	.01	55	81	112	158			28	28	27	27	26								
			50		.04	.01	.01	.01	.01							.69	1.3	2.0	2.6	3.6								
			70	2.5	.04	.01	.01	.01	.01	55	82	112	158	210			29	29	28	28	27	27						
			100		.05	.02	.01	.01	.01								.75	1.4	2.2	2.7	3.7	4.8						
			150	2.5	.05	.02	.01	.01	.01	55	82	112	158	210			30	30	29	29	28	28	28	26				
			200		.05	.02	.01	.01	.01								.84	1.5	2.4	2.8	3.8	4.9	6.8	8.8				
			300	2.5	.08	.03	.02	.01	.01	56	83	112	158	210			30	30	30	30	29	29	29	28				
			500		.13	.05	.03	.01	.01								1.2	1.8	2.5	3.0	3.9	5.0	6.9	8.8				
		750	2.5	.20	.07	.04	.02	.01	56	83	112	158	210			31	30	30	30	30	30	30	29					
		1,000		.26	.10	.05	.02	.01								1.7	2.1	2.5	3.0	4.0	5.0	6.9	8.9					
		2,000	2.6	.53	.19	.10	.04	.01	58	85	114	158	210			31	31	31	30	30	30	30	30					
		3,500		.92	.34	.17	.07	.02								2.5	2.9	3.4	4.0	4.9	6.0	8.0	9.8					
		5,000	2.7	1.31	.48	.24	.10	.04	60	87	116	159	211			31	31	30	30	30	30	30	30					
		7,500		1.97	.73	.36	.15	.05								3.2	4.0	4.7	5.1	6.0	7.0	9.1	11					
		10,000	2.8	2.63	.97	.48	.20	.07	62	89	119	160	212			31	31	30	30	30	30	30	30					
		15,000		3.93	1.45	.71	.30	.10								4.0	4.8	5.6	6.0	6.8	7.9	10	12					
		20,000	2.9	5.25	1.93	.95	.40	.14	65	92	122	160	212			31	30	30	30	30	30	30	29					
		25,000		6.56	2.42	1.19	.50	.17								5.0	5.4	5.9	6.3	7.4	8.5	11	13					
50,000	4.1	13.1	4.83	2.37	1.00	.34	68	95	125	163	215			31	30	30	30	30	30	30	29							
75,000		19.7	7.25	3.56	1.49	.50								7.6	8.2	8.5	9.2	11	11	13	16							
100,000	5.6	26.3	9.66	4.75	1.99	.67	72	99	129	167	219			31	30	30.5	30	30	30	30	29							
150,000		-	-	-	-	-								9.4	10	11	12	14	14	15	18							
200,000																												
250,000																												

(NOTE) For speeds not shown on the pump hydraulic charts, consult factory.

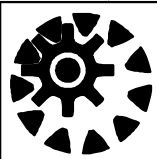

# JG

## PUMP HYDRAULIC SIZE CHART

SEC. 500

Page 66

January 2010

**20 GPM  
580 RPM**

NOMINAL		ROTOR TRIM	VISCOSITY (SSU)	N.I.P.R. (PSIA)	FRICTION PIPE LOSS (PSI/FT) <small>(Based on Sch 40 Steel Pipe)</small>					FULL BYPASS RELIEF VALVE PRESSURE (PSI)					CAPACITY (GPM) / H.P. REQUIRED											
CAP. GPM	SPEED RPM				PIPE DIAMETER					CRACKING PRESS. (PSI)					DIFFERENTIAL PRESSURE (PSI)											
					1½"	2"	2½"	3"	4"	LOW PRES R/V			HI PRES R/V		MEDIUM DUTY AND HEAVY DUTY				HEAVY DUTY ONLY							
20	580	STD	28	1.5	.01	.01	.01	.01	.01	54	80	110				18	17	16	16							
			32		.01	.01	.01	.01	.01							.41	.82	1.2	1.6							
			38	1.5	.02	.01	.01	.01	.01	54	80	110	157			18	18	17	17	16						
			50		.02	.01	.01	.01	.01							.44	.89	1.2	1.7	2.4						
			70	1.5	.02	.01	.01	.01	.01	54	80	110	157	208			19	18	18	18	17	17				
			100		.02	.01	.01	.01	.01								.50	.98	1.3	1.7	2.5	3.1				
			150	1.5	.03	.01	.01	.01	.01	55	81	110	157	208			19	19	19	19	18	18	18	17		
			200		.04	.01	.01	.01	.01								.58	1.1	1.4	1.8	2.5	3.2	4.4	5.9		
			300	1.5	.05	.02	.01	.01	.01	55	81	110	157	208			20	20	19	19	19	19	18	18		
			500		.09	.03	.02	.01	.01								.65	1.2	1.6	1.9	2.5	3.2	4.5	5.9		
		750	1.5	.13	.05	.03	.01	.01	55	81	110	157	208			20	20	20	20	20	20	19	19			
		1,000		.18	.07	.03	.01	.01								.83	1.4	1.7	2.1	2.7	3.3	4.6	6.0			
		2,000	1.7	.35	.13	.06	.02	.01	56	82	111	158	209			20	20	20	20	20	20	19	19			
		3,500		.61	.23	.11	.05	.02								1.5	1.9	2.3	2.7	3.4	4.1	5.4	6.8			
		5,000	1.8	.88	.32	.16	.07	.02	57	83	112	159	210			20	20	20	20	20	20	20	19			
		7,500		1.31	.48	.24	.10	.04								1.9	2.3	2.7	3.1	3.8	4.5	5.9	7.2			
		10,000	2.0	1.75	.65	.32	.13	.05	58	85	113	160	211			20	20	20	20	20	20	20	20			
		15,000		2.63	.97	.48	.20	.07								2.4	2.8	3.2	3.6	4.3	5.0	6.4	6.7			
		20,000	2.1	3.50	1.29	.63	.27	.09	60	87	114	160	211			20	20	20	20	20	20	20	20			
		25,000		4.38	1.61	.79	.33	.11								2.8	3.1	3.5	3.9	4.6	5.3	6.8	8.2			
50,000	3.3	8.75	3.22	1.58	.67	.23	62	89	116	162	213			20	20	20	20	20	20	20	20					
75,000		13.1	4.83	2.37	1.00	.34								4.2	4.7	5.1	5.6	6.7	7.2	8.5	10					
100,000	4.7	17.5	6.44	3.17	1.33	.45	65	92	119	165	216			20	20	20	20	20	20	20	20					
150,000		26.3	9.66	4.75	1.99	.67								5.3	5.9	6.4	7.0	8.3	8.6	9.9	12					
200,000	8.6	35.0	12.9	6.33	2.65	.90	68	95	122	168	219			20	20	20	20	20	20	20	20					
250,000		-	-	-	-	-								6.3	7.0	7.4	8.2	9.8	9.9	11	13					

(NOTE) For speeds not shown on the pump hydraulic charts, consult factory.

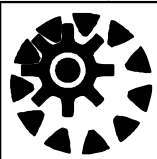

# JG

## PUMP HYDRAULIC SIZE CHART

SEC. 500

Page 67

January 2010

**12 GPM  
350 RPM**

NOMINAL		ROTOR TRIM	VISCOSITY (SSU)	N.I.P.R. (PSIA)	FRICTION PIPE LOSS (PSI/FT) <small>(Based on Sch 40 Steel Pipe)</small>					FULL BYPASS RELIEF VALVE PRESSURE (PSI)					CAPACITY (GPM) / H.P. REQUIRED														
CAP. GPM	SPEED RPM				PIPE DIAMETER					CRACKING PRESS. (PSI)					DIFFERENTIAL PRESSURE (PSI)														
					1½"	2"	2½"	3"	4"	LOW PRES R/V			HI PRES R/V		MEDIUM DUTY AND HEAVY DUTY				HEAVY DUTY ONLY										
12	350	STD	28	1.1	.01	.01	.01	.01	.01	53	79	105			11	10	10	9.5											
			32		.01	.01	.01	.01	.01						.26	.52	.73	.98											
			38	1.1	.01	.01	.01	.01	.01	53	79	105	154			11	10	10	10	9.5									
			50		.01	.01	.01	.01	.01							.29	.55	.78	.99	1.5									
			70	1.1	.01	.01	.01	.01	.01	53	79	105	154	204			11	11	11	11	10	10							
			100		.01	.01	.01	.01	.01								.32	.58	.80	1.0	1.5	1.9							
			150	1.1	.02	.01	.01	.01	.01	54	80	106	155	205			12	11	11	11	11	11	10	10					
			200		.02	.01	.01	.01	.01								.37	.62	.84	1.1	1.6	1.9	2.7	3.5					
			300	1.1	.03	.01	.01	.01	.01	54	80	106	155	205			12	12	12	11	11	11	11	11	11				
			500		.05	.02	.01	.01	.01								.43	.69	.93	1.1	1.6	2.0	2.8	3.6					
		750	1.1	.08	.03	.02	.01	.01	54	80	106	155	205			12	12	12	12	12	12	11	11						
		1,000		.11	.04	.02	.01	.01								.59	.80	1.0	1.2	1.7	2.1	2.9	3.7						
		2,000	1.3	.21	.08	.04	.02	.01	54	80	106	155	205			12.	12	12	12	12	12	12	12	11					
		3,500		.37	.14	.07	.03	.01								.82	1.1	1.3	1.6	2.0	2.4	3.2	4.0						
		5,000	1.5	.53	.19	.10	.04	.01	55	80	106	155	205			12	12	12	12	12	12	12	12	11					
		7,500		.79	.29	.14	.06	.02								.96	1.2	1.4	1.7	2.2	2.6	3.4	4.3						
		10,000	1.7	1.05	.39	.19	.08	.03	56	81	107	156	206			12	12	12	12	12	12	12	12	12					
		15,000		1.58	.58	.29	.12	.04								1.1	1.4	1.6	1.9	2.4	2.8	3.7	4.6						
		20,000	1.8	2.10	.77	.38	.16	.06	56	82	108	156	206			12	12	12	12	12	12	12	12	12					
		25,000		2.63	.97	.48	.20	.08								1.3	1.5	1.8	2.5	2.9	3.0	3.9	4.7						
50,000	3.0	5.25	1.93	.95	.40	.14	58	84	110	158	208			12	12	12	12	12	12	12	12	11							
75,000		7.88	2.90	1.43	.60	.20								2.0	2.3	2.6	2.9	3.4	4.0	4.8	5.9								
100,000	4.5	10.5	3.87	1.90	.80	.27	60	86	112	160	210			12	12	12	12	12	12	12	12	11							
150,000		15.8	5.80	2.85	1.20	.40								2.5	2.9	3.2	3.7	4.0	4.8	5.6	6.7								
200,000	7.0	21.0	7.73	3.80	1.59	.54	62	88	114	162	212			12	12	12	12	12	12	12	12	11							
250,000		26.3	9.66	4.75	1.99	.67								3.0	3.5	3.8	4.3	4.6	5.5	6.3	7.4								

(NOTE) For speeds not shown on the pump hydraulic charts, consult factory.